

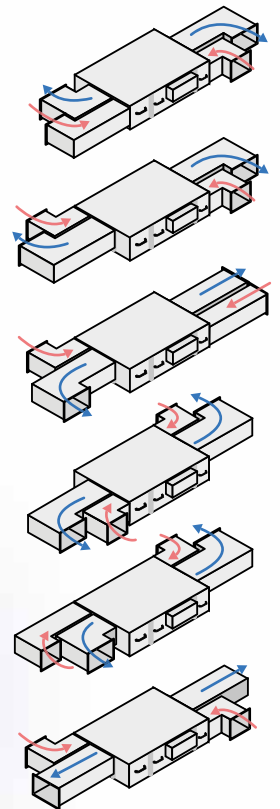

NOW AVAILABLE WITH NEW BEND SILENCERS



XBOXER XBC

HEAT RECOVERY SOLUTIONS
ENERGY EFFICIENT PRODUCT RANGE

WITH NEW **ecosmart** CONTROL PLATFORM



FOR THE COMPLETE VENTILATION SOLUTION



XBOXER XBC HEAT RECOVERY SOLUTIONS, OFFER THE MOST EFFICIENT, COMPACT DESIGN & QUIETEST SOLUTION AT THE LOWEST INSTALLED COST

▼XBC85-V-LCO
Vertical fan unit shown. Ecosmart Connect control panel fitted internally.

HIGH EFFICIENCY UP TO 92%



WHICH UNIT DO YOU REQUIRE?

| Model | m ³ /s | 0 | 0.1 | 0.2 | 0.3 | 0.4 | 0.5 | 0.6 | 0.7 | 0.8 | 0.9 | 1 | 2 | 3 | Page No. |
|-------|-------------------|--|-----|-----|-----|-----|-----|-----|-----|-----|-----|---|---|---|----------|
| XBC10 | | [Bar chart showing flow rate up to ~0.15 m³/s] | | | | | | | | | | | | | 16 |
| XBC15 | | [Bar chart showing flow rate up to ~0.25 m³/s] | | | | | | | | | | | | | 18 |
| XBC25 | | [Bar chart showing flow rate up to ~0.4 m³/s] | | | | | | | | | | | | | 20 |
| XBC45 | | [Bar chart showing flow rate up to ~0.55 m³/s] | | | | | | | | | | | | | 22 |
| XBC55 | | [Bar chart showing flow rate up to ~0.65 m³/s] | | | | | | | | | | | | | 24 |
| XBC65 | | [Bar chart showing flow rate up to ~0.8 m³/s] | | | | | | | | | | | | | 26 |
| XBC75 | | [Bar chart showing flow rate up to ~1.0 m³/s] | | | | | | | | | | | | | 36 & 40 |
| XBC85 | | [Bar chart showing flow rate up to ~1.2 m³/s] | | | | | | | | | | | | | 38 & 42 |

- **UK's No. 1** - Energy efficient range of packaged heat recovery units
- **LOWEST NOISE** - Patented construction
- **HIGHEST EFFICIENCY** - Exceeding Part L and Section 6 requirements aiding energy modelling and BREEAM
- **COMPACT AND FLEXIBLE** - Allows for quick and simple onsite installation
- **EXTENSIVE CONTROL SOLUTION** - Ecosmart Control Platform can provide optimum building efficiency (BMS/BEMS)
- **PACKAGED SOLUTION** - Lowest installed cost available on the market
- **UK DESIGNED, DEVELOPED AND MANUFACTURED** - Stocked and available in 10 days*
- **5 YEAR WARRANTY*** - Peace of mind

*Contact Nuaire for details.

▼ XBC75-H-LAT Horizontal fan unit shown.
Unit has **Adapt Trend** control.



▼ XBC45-H-LES Horizontal fan unit
with **Ecosmart Classic** control.

**HIGH
EFFICIENCY
UP TO
96%**

XBC MARKET LEADING HEAT RECOVERY - CONTENTS

| | | | | | |
|--|-----------|---------------------------------------|-----------|---|-----------|
| XBC10-85 RANGE | 3 | XBC10-65 TECHNICAL DATA | 16 | CONSTANT PRESSURE | 50 |
| 1. XBC10-65 features & benefits | 4 | 1. XBC10 | 16 | 1. How Constant Pressure works | 50 |
| 2. XBC75-85 features & benefits | 6 | 2. XBC15 | 18 | 2. Constant Pressure Dampers | 51 |
| ECOSMART CONTROL PLATFORM | 7 | 3. XBC25 | 20 | 3. Constant Pressure Performance and Technical Information | 52 |
| 1. History & Pedigree | 7 | 4. XBC45 | 22 | OUR CUSTOMERS | 54 |
| 2. Overview of Ecosmart Control Platform | 8 | 5. XBC55 | 24 | 1. Project Specific Solutions | 54 |
| 3. Basic Control (BC) | 9 | 6. XBC65 | 26 | 2. Alternative Heat Recovery Solutions | 56 |
| 4. Ecosmart Classic Control (ES) | 9 | 7. XBC10-65 Ancillaries | 28 | | |
| 5. Ecosmart Connect Control (CO) | 9 | 8. XBC10-65 NEW Bend Silencers | 30 | | |
| 6. Ecosmart Adapt Control (AT) | 9 | 9. XBC10-65 Consultant Specifications | 32 | | |
| 7. Features of Ecosmart Platform | 10 | 10. XBC10-65 Unit Wiring | 34 | | |
| 8. Ecosmart Sensors & Enablers | 12 | XBC75-85 TECHNICAL DATA | 36 | | |
| SELECTION & REGULATIONS | 14 | 1. XBC75 Horizontal | 36 | | |
| 1. BIM support & library | 14 | 2. XBC85 Horizontal | 38 | | |
| 2. Building regulations | 15 | 3. XBC75 Vertical | 40 | | |
| | | 4. XBC85 Vertical | 42 | | |
| | | 5. XBC75-85 Ancillaries | 44 | | |
| | | 6. XBC75-85 Consultant Specifications | 46 | | |
| | | 7. XBC75-85 Unit Wiring | 48 | | |

XBOXER XBC10-65 ENERGY EFFICIENT HEAT RECOVERY UNITS WITH SPECIALIST ACOUSTIC TREATMENT PROVIDING LOW NOISE LEVELS



XBC65-H-LCO ▶



UP TO
96%
EFFICIENCY

◀ XBC45-H-LES

LOWER NOISE & ENERGY CONSUMPTION

■ **GUARANTEED LOW SOUND LEVELS** - Units have Asymmetric, high mass, double skinned wall construction (patented) with integral acoustic barrier mat (XBC10 units contain specialist acoustic treatment) ensuring low breakout noise levels.

■ **LATEST EC TECHNOLOGY** - Performance optimised backward curved impellers and IP54 EC motors provide low specific fan powers and stepless speed control without tonal noise generation.

■ **MEETS CURRENT LEGISLATION AND BUILDING REGULATIONS** - Lower energy consumption and better SBEM score.

■ **CONTINUOUS ACOUSTIC HOUSING** - Matched silencers reduce breakout and provide a superior acoustic solution.

■ **CLASS L2 LEAKAGE** - Units are tested to meet Class L2 leakage requirements.

ACHIEVES BUILDING REGULATIONS

■ **HIGH EFFICIENCY HEAT EXCHANGER** - Counterflow heat exchanger (Eurovent certified) with efficiencies of up to 96% with segmented 100% bypass (patent applied for) automatic control and actuator.

■ BUILT IN ECOSMART CLASSIC, CONNECT OR ADAPT (TREND) CONTROL OPTIONS

Ecosmart Energy efficient demand control ventilation solution. Ecosmart Connect control option delivers extensive flexibility and capability and uses Ethernet technology to integrate into supervisory control networks using BACnet. See page 8 for further details. Ecosmart Adapt allows for project specific controls i.e. Trend or Siemens. Contact Nuair for details.

■ **SPACE SAVING SOLUTION** - Low casing height from 260mm for ceiling/under floor/slab mounted applications. Most compact case by duty size.

■ **AIR QUALITY** - Optional duct or surface mounted sensors to monitor CO₂ levels as required in BB101. Refer to pages 12 - 13.

UNIQUE INTELLIGENT DESIGN PRACTICE

■ **100% INTEGRATED SUMMER BYPASS** - The bypass operates automatically via integrated temperature sensors and pre-defined control algorithm/ programme.

■ **QUICK COMMISSIONING** - Integrated supply and extract fan allows precise system duty which can be quickly and accurately set. (Ecosmart models only).

■ **UNIQUE LAYOUT DESIGN** - Provides flexibility in unit ductwork connections – Supply/Discharge connections are on unit centreline. Intake/Extract connections are configurable on site to either side of the unit.

■ **FLEXIBLE ACOUSTIC COMPACT SUPPLY & EXTRACT SECTION** - Double skinned acoustically lined compact section with supply and discharge channel ready for ducting to be attached. Ideal for space restricted ceiling voids.

BASIC CONTROL OPTIONS

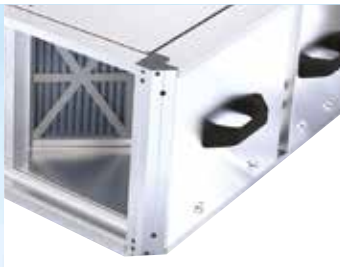

▲ Lowest depth (from 260mm) units available, ideal for space restricted ceilings.



▲ Matched silencers are separate and can be fitted to suit left/right side. (1050/1250/1600mm lengths).



▲ All Ecosmart Control Platforms have a 90° pivoting control box for easy commissioning.



▲ Double skinned wall construction (patented) integral acoustic barrier mat.

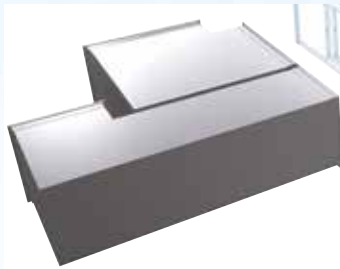

▲ Bend silencers are available for projects where straight matched silencers cannot be fitted.



▲ Optional exhaust and intake terminals for all models. Code examples: XBC15-EXHAUST-RT & XBC15-INTAKE-RT.



▲ Only 260mm clearance required for filter access (Ecosmart models). 2 spare filters included (G4).



▲ Mounting brackets incorporated into the unit. Units fit flush to slab.

FLEXIBLE SOLUTION

■ **HEATING COIL OPTIONS** - Units are fitted with LPHW heater battery, 4-port valve and actuator or Electric heater battery and burst fired temperature controller. No heater option is also available. (For DX & cooling modules contact Nuair).

■ **BASIC CONTROL OPTION AVAILABLE** - Allowing for a control system to be designed, specified, fitted & tested by others.

■ **WEATHER PROTECTION** - Weather roof can be selected as an ancillary on all models and fitted on site.

■ **MANUFACTURED IN UK** - All units are manufactured in the UK. Contact Nuair for details of availability.

■ **ENERGY EFFICIENT DEMAND CONTROL** - Ecosmart control compatibility provides a simple 'plug & go' control solution for stand-alone control with trickle & boost operation as standard. A variety of BMS interface options are available.

SAVES TIME & MONEY ON SITE

■ **MANUFACTURED FROM CORROSION RESISTANT ALUZINC** - Aluzinc can last 5 times longer than galvanised steel providing higher wear resistance.

■ **HIGH CAPACITY FILTERS** - Units are fitted with four high capacity pleated G4 filters (spare filters are included in unit). F7 filters are available. (Note: XBC10 has G3 filters).

■ **NEW ECOSMART CONNECT CONTROL SYSTEM** - Stand-Alone control and full BMS via BACnet (MS/TP). The system controller is augmented by application specific unit interface and diagnostic circuits. Controller software is pre-configured and the unit/control assembly is functionally tested at works (Refer to Ecosmart Control brochure for technical details).

■ **EASY MAINTENANCE** - Side access as standard will provide full access to components and for quick filter removal and replacement. Bottom access is available for filter only. Example code is XBC15-HLES-BA. (Only on sizes 10-45).

MAKES LIFE EASIER

■ **EASY FIT DOUBLE SKINNED MATCHED SILENCERS WITH QUICK FIT BRACKET** - Can be easily incorporated into existing drop roof supporting systems. 3 lengths of matching silencers are available, 1050, 1250 and 1600mm. Fixing kit included. **All XBC matched silencers are double skinned.**

■ **ADVANCED CONDENSATE REMOVAL** - Miniature condensate pump fitted as standard and incorporates an alarm function. **If alarm is triggered unit will automatically be placed in bypass mode preventing further condensate production. Unit operation will otherwise be unaffected.**

■ **WIDE RANGE OF ANCILLARIES & FILTERS** - Includes matched silencers, weather roof, F7 filters, roof terminals and NEW bend silencers.

■ **5 YEAR WARRANTY** - On Ecosmart Classic, Ecosmart Connect and Adapt models for peace of mind. Basic control models have a 2 year warranty.

XBOXER XBC75-85 ENERGY EFFICIENT HEAT RECOVERY UNITS

WITH DUTY UP TO 1.5m³/s



NEW
HIGH EFFICIENCY
COUNTERFLOW
HEAT EXCHANGER
UP TO 92%

XBC85-V-LCO ▶
Vertical unit fitted with
Ecosmart Connect control.



▲ **XBC75-H-LAT**
Horizontal unit fitted with
Ecosmart Adapt Trend control.

LOWER NOISE & ENERGY CONSUMPTION

- **VERY LOW SOUND LEVEL SOLUTION** - Units have a rigid pentapost framework with 25mm infill panels containing inert high density acoustic infill ensuring low breakout noise levels.
- **LATEST EC TECHNOLOGY** - Performance optimised backward curved impellers and IP54 EC motors provide low specific fan powers and stepless speed control without tonal noise generation.
- **MEETS CURRENT LEGISLATION AND BUILDING REGULATIONS** - Lower energy consumption and better SBEM score.
- **CONTINUOUS ACOUSTIC HOUSING** - Matched silencer modules help reduce breakout and provide a superior acoustic solution.
- **CLASS L2 LEAKAGE** - Units are tested to meet Class L2 leakage requirements.

ACHIEVES BUILDING REGULATIONS

- **HIGH EFFICIENCY HEAT EXCHANGER** - Counterflow heat exchanger (Eurovent certified) with efficiencies of up to 92% with segmented 100% bypass (patent applied for) automatic control and actuator.
- **BUILT IN ECOSMART CLASSIC, CONNECT OR ADAPT (TREND) CONTROL OPTIONS** - Ecosmart Energy efficient demand control ventilation solution. Ecosmart Connect control option delivers extensive flexibility and capability and uses Ethernet technology to integrate into supervisory control networks using BACnet. See page 8 for further details. Ecosmart Adapt allows for project specific controls i.e. Trend or Siemens. Contact Nuair for details.
- **CONSTANT PRESSURE OPTION*** - Improves the energy performance of a building using a centralised ventilation system, and guarantees lower energy costs for the end user. (Applies to ES CO & AT models only). Refer to page 50 for further details on Constant Pressure.

UNIQUE INTELLIGENT DESIGN PRACTICE

- **SPACE SAVING SOLUTION** - Ideal for plant room/roof top applications. Most compact case by duty size.
- **AIR QUALITY** - Optional duct (ES-CO₂) or surface (ES-CO₂RM) mounted sensors to monitor CO₂ levels as required in BB101.
- **100% INTEGRATED SUMMER BYPASS** - The bypass operates automatically via integrated temperature sensors and a pre-defined control algorithm/programme.
- **ECOSMART PRE-PROGRAMMED SOFT START FUNCTION** - Helps prevent electrical overloading and minimises mechanical wear.
- **QUICK COMMISSIONING** - Integrated supply and extract fan allows precise system duty which can be quickly and accurately set. (Ecosmart Classic, Connect & Adapt models only).

BASIC CONTROL OPTIONS



▲ Integral base frame (76mm high) with slots for forklift arms ensure easy manoeuvrability on site.



▲ Fans slide out for ease of maintenance.



▲ Wide range of frost coils and dampers. LPHW heater battery supplied with 2 port PICV valve and actuator.

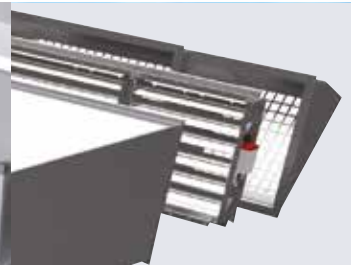

▲ Range of weather kits, exhaust / intake and roof terminals available.



▲ G4 filters as standard other options available, contact Nuair.



▲ Weather roofs are factory fitted only. Code example XBC85-V-LESWP.



▲ Double deck silencer modules 900mm length incorporate base frame.



▲ Quick access to fans, heat exchangers, condensate and control panel.

FLEXIBLE SOLUTION

■ **HEATING COIL OPTIONS** - Units are fitted with LPHW heater battery, 2-port valve and actuator or Electric heater battery (contact Nuair for details). No heater option is also available as standard. (For DX, cooling and chilled water modules contact Nuair).

■ **BASIC CONTROL OPTION AVAILABLE** - Allowing for a control system to be designed, specified, fitted and tested by others.

■ **WEATHER PROTECTION** - Weather roof is factory fitted only. Code example XBC85-V-LESWP.

■ **MANUFACTURED IN UK** - Contact Nuair to ensure your required project deadlines are met.

■ **ENERGY EFFICIENT DEMAND CONTROL** - Ecosmart control compatibility provides a simple 'plug & go' control solution for stand-alone control, with trickle and boost operation as standard. A variety of BMS interface options are available.

SAVES TIME & MONEY ON SITE

■ **NEW ECOSMART CONNECT CONTROL SYSTEM** - Allows Stand-Alone control and full BMS integration via BACnet (MS/TP). The system is augmented by application specific unit interface and diagnostic circuits. Controller software is pre-configured and the unit/control assembly is functionally tested at works (Refer to Ecosmart Control brochure for technical details).

■ **HIGH CAPACITY FILTERS** - Units are fitted with two high capacity G4 panel filters. F7 filter modules are available.

■ **MANUFACTURED FROM CORROSION RESISTANT ALUZINC** - Aluzinc can last 5 times longer than galvanised steel providing higher wear resistance.

■ **EASY MAINTENANCE** - Side access as standard providing full access to internal components.

■ **MATCHING SILENCERS** - Quick and easy to fit on site.

MAKES LIFE EASIER

■ **ADVANCED CONDENSATE REMOVAL** - Miniature condensate pump fitted as standard and incorporates an alarm function. If alarm is triggered unit will automatically be placed in bypass mode preventing further condensate production. Unit operation will otherwise be unaffected.

■ **WIDE RANGE OF ANCILLARIES & FILTERS** - Includes matched silencers, F7 filters and roof terminals.

■ **5 YEAR WARRANTY** - On Ecosmart Classic and Ecosmart Connect models for peace of mind. Basic control models have a 2 year warranty.

ECOSMART CONTROL PLATFORM - IT'S SO SMART IT'S SIMPLE

DEMAND VENTILATION SOLUTIONS – DESIGNED FOR EFFICIENCY AND PERFORMANCE

Nuaire have a pedigree for designing and manufacturing energy efficient ventilation equipment and matched control systems. Our very first control was produced in the late 1980's.

Nuaire was the first ventilation manufacturer to introduce low voltage energy saving control systems. Its fans with 'Ecosmart' technology varied the ventilation rate to suit occupant levels. Ecosmart was launched in 2002 and was revolutionary within the industry by providing the first "plug and play" control system.

Nuaire continues to lead in the industry with the expansion of their Ecosmart Controls Platform.



Energy efficient demand based control fitted with Trend IQ422 controller. Allows for unitary control and full BMS integration via BACnet IP (by others).
Controller software is basic and ready for 'project specific' program to be loaded.
Ecosmart Adapt with Trend has a 5 year warranty.
For other options of Ecosmart Adapt contact Nuaire.



NEW Energy efficient demand based control providing a network connectivity and advanced functionality. Full BMS integration via BACnet (MS/TP). (Upgrade to IP network available). Ecosmart Connect has a 5 year warranty.



UK's leading Energy Efficient 'plug and play' solution for over 20 years. Provided with BMS interface, trickle and boost as standard.
Ecosmart Classic has a 5 year warranty.

**THE MOST SUCCESSFUL ENERGY CONTROL EVER -
DEMAND VENTILATION AT YOUR FINGER TIPS**

BASIC CONTROL

Supplied with terminal box for supply and extract fan motor wiring and for interfacing to custom built control panels (by others). Basic control has a 2 year warranty.

ECOSMART CONTROL PLATFORM - IT'S SO SMART IT'S SIMPLE

ECOSMART ADAPT

TREND IQ422/12/LAN/BAC/230 INSIDE WITH FULL BMS INTEGRATION VIA BACNET.

"The management and control of modern buildings grow ever more sophisticated. A Building Energy Management system (BEMS) must be tailored to suit each customer's specific control requirements. It must provide efficient HVAC control, coupled with the flexibility to accommodate changes in occupancy status and staff relocation at short notice; whilst simultaneously delivering improved comfort conditions. A BEMS must also provide real time management information and control, enabling customers to achieve significant energy savings". (TREND)

Ecosmart Adapt with Trend provides control of the ventilation including the heating, or cooling allowing unitary control and full BMS integration via BACnet IP. The Ecosmart Adapt with Trend control system includes an IQ422/12/LAN/BAC/230 controller which is pre-configured and the unit and control assembly is functionally tested at Nuaire before customer delivery.

REDUCED INSTALLATION & ON-SITE COMMISSIONING TIME ON NEW & RETROFIT PROJECTS -

Advanced tools within the control automate many tasks, simple to use displays minimise data input, whilst reducing commission time and potential human error.

- **Ease of use** - Using Ecosmart Adapt with Trend will deliver substantial savings on utility costs.
- **Peace of mind** - Ecosmart Adapt with Trend has a 5 year warranty. (Example Code: XBC75-H-LAT)

ECOSMART CONNECT

Ecosmart Connect provides control of the ventilation including the heating, or cooling allowing unitary control and full BMS integration via BACnet (MS/TP). (Upgrade to IP network available).

The Ecosmart Connect controller is pre-configured and the unit and control assembly is functionally tested at Nuaire before customer delivery.

REDUCED INSTALLATION & ON-SITE COMMISSIONING TIME ON NEW & RETROFIT PROJECTS -

Advanced tools within the control automate many tasks, simple to use displays minimise data input, whilst reducing commission time and potential human error.

- **Ease of use** - Using Ecosmart Connect will deliver substantial savings on utility costs.
- **Peace of mind** - Ecosmart Connect has a 5 year warranty. (Example Code: XBC75-H-LCO)

ECOSMART CLASSIC

Varying the ventilation rate in a building to suit changing occupant levels used to be an expensive option – Ecosmart brings this within everyone's pocket. Minimising energy losses through re-heating (or cooling) the air replaced through ventilation is at the top of the agenda; building regulations make this a necessity. Ecosmart not only saves energy and carbon emissions it prolongs the life of the heat recovery unit.

Choosing Ecosmart is your reliable option, used by design engineers for many years and is now an integral feature of most Nuaire fans.

- **Saves time on site** - Ecosmart controls are all pre-assembled, configured and installed directly into the heat recovery units, this includes valves and actuators, pipework etc. which helps significantly reduce the time spent on site.
- **Simpler system** - No need for VCD (directly on the fan) no wasted energy or noise generation because air volume can be precisely set via integrated speed control.

(Example Code: XBC75-H-LES)

- **Simple & precise commissioning** - As recommended in Part L, Ecosmart enables the system to be accurately commissioned via integrated speed control. If the unit is controlled by 0-10V BMS the system's response to a 0-10V dc BMS signal is given in the table below.

| | Ventilation mode | Cooling mode* | Heating mode* |
|---------------|------------------|---------------|---------------|
| Local control | 0.00 | - | - |
| OFF / trickle | 0.25 | - | - |
| Speed 1 | 0.50 | 0.75 | 1.00 |
| Speed 2 | 1.50 | 1.75 | 2.00 |
| Speed 3 | 2.50 | 2.75 | 3.00 |
| Speed 4 | 3.50 | 3.75 | 4.00 |
| Speed 5 | 4.50 | 4.75 | 5.00 |
| Speed 6 | 5.50 | 5.75 | 6.00 |
| Speed 7 | 6.50 | 6.75 | 7.00 |
| Speed 8 | 7.50 | 7.75 | 8.00 |
| Speed 9 | 8.50 | 8.75 | 9.00 |
| Speed 10 | 9.50 | 9.75 | 10.00 |

* Only available on relevant unit.

BASIC CONTROL

Basic control is fan speed only and are suitable for 2-10V adjustment (by others). The heat recovery unit will have a side mounted terminal box for connection to the fans (230V, 50Hz LNE and 2-10V*) and bypass actuator (where applicable). Basic control is for BMS by others.

Basic control has a 2 year warranty. *For XBC 75 and XBC 85 (400V 3ph, 50Hz LNC and 2 - 10V).

(Example Code: XBC75-H-LBC)

ECOSMART CONTROL PLATFORM - IT'S SO SMART IT'S SIMPLE

| | BASIC CONTROL (BC) | ecosmart classic (ES) | ecosmart CONNECT (CO) BACnet (MS/TP) | ecosmart adapt (AT) Based on TREND IQ44 BACnet (IP) |
|--|------------------------------|---------------------------------|--|---|
| CONTROLLER SOFTWARE | | | | |
| Controller Software | | N/A | Advanced Software | Basic Software (Can be re-written by others) |
| Heat Exchange Bypass Control Strategy | | Basic | Optimised | Basic |
| Supply Temperature Control Strategy | | Yes | Yes | Yes |
| Room Temperature Control Strategy | | No | Yes | No |
| Switched Live Enable Input | | Yes | Yes | Yes |
| Switched Live Fan Boost | | No | No | Yes |
| Switched Live Configurable Input (Heat or Fan Boost) | | No | Yes | No |
| Volt Free Enable Input | | No | Yes | Yes |
| Volt Free Fan Boost | | No | No | Yes |
| Volt Free Configurable Input (Heat or Fan Boost) | | No | Yes | No |
| Trickle Mode | | Yes | Yes | Yes |
| Fan Run-On | | Yes | Yes | Yes |
| Fan Run-On (Intelligent) | | No | Yes | No |
| Run/Fault/Heat/Cool Volt Free Outputs | | Yes | Yes | Yes |
| I/O Damper control | | Yes | Yes (via run relay) | Yes (via run relay) |
| Heat Dissipation Run-on | | Yes | Yes | Yes |
| Frost Protection Routine | | Yes | Yes | Yes |
| Low Supply Temp Fan Cut-out | | No | Yes | Yes |
| Scheduling | | Yes via ES-LCD | Yes | Yes |
| CO2 Based Fan PID Loop | | ES-CO2 | Yes | Yes |
| Humidity Based Fan PID Loop | | ES-HUMIDISTAT2 | Yes | No |
| Pressure Based Fan PID Loop | | CP version available | Yes | No |
| Night Cooling Mode | | No | Yes | Yes |
| Purge Mode | | No | Yes | Yes |
| Hibernate Mode (Open all valves) | | No | Yes | No |
| Fan Speed Adjustment | | Yes | Yes | Yes |
| Fan Speed Control only | Yes | No | No | No |
| 0 - 10V Fan speed Input | | Yes | Yes | Yes |
| 0 - 10V Temperature Sensor Input | | No | Yes | No |
| 0 - 10V Humidity Sensor Input | | No | Yes | No |
| 0 - 10V Pressure Sensor Input | | No | Yes | No |
| 0 - 10V CO2 Sensor Input | | No | Yes | No |
| CONTROLLER HARDWARE | | | | |
| Fail safe thermal trip | | Yes | Yes | Yes |
| Condensate Pump Monitoring | | Yes | Yes | Yes |
| Din Rail Mounted Control | | No | Yes | Yes |
| Quick Connect Terminals | | No | Yes | Yes |
| 24VAC Auxiliary | | No | Yes | Yes |

ECOSMART CONTROL PLATFORM - IT'S SO SMART IT'S SIMPLE

| | BASIC CONTROL (BC) | ecosmart classic (ES) | ecosmart CONNECT (CO) BACnet (MS/TP) | ecosmart adapt (AT) Based on TREND IQ44 BACnet (IP) |
|---------------------------------|-----------------------|--------------------------------|--|--|
| HMI | | | | |
| Commissioning Display | | Yes only Via commissioning PCB | Yes | By Others |
| BACnet LCD Touch Screen Display | | No | Yes | By Others |
| ROOM MODULES | | | | |
| Plug & Play Sensors | | Yes | Yes | No |
| Max Number of Sensors | | 32 devices on any system | 4 sensor modules* | By Others |
| Quick connect plugs | | Yes | Yes | By Others |
| Twisted pair cable compatible | | No | Yes | By Others |
| Commissioning Port | | No | Yes | By Others |
| Temperature | | Yes | Yes | By Others |
| CO2 | | Yes | Yes | By Others |
| Humidity | | Yes | Yes | By Others |
| 3-Speed Override | | No | Yes | By Others |
| PIR | | Yes | Yes | By Others |
| Setpoint Adjust | | Yes (on sensor) | Yes | By Others |
| Multiple Setpoints Supported | | No | Yes | By Others |
| Room Temperature Display | | No | Yes | By Others |
| Room Humidity Display | | No | Yes | By Others |
| Fan Speed Display | | No | Yes | By Others |
| Occupancy Status Display | | No | Yes | By Others |
| Network Error Display | | Yes | Yes | By Others |
| NETWORKING | | | | |
| BEMS compatible | | No | Yes | Yes |
| BMS compatible | | 0-10V Input | BACnet via MS/TP (BACnet via IP optional) | (BACnet via IP) |
| MONITORING | | | | |
| Web connectivity | | NA | Yes | Yes |
| Energy Monitoring | | NA | Yes | Participation via Trend network |
| Energy Metering | | NA | Yes | Participation via Trend network |

*Each sensor module can have multiple sensors.

For further details of Ecosmart Controls Platform, refer to website: www.nuaire.co.uk

ECOSMART CONTROL PLATFORM - IT'S SO SMART IT'S SIMPLE

ecosmart SENSORS & ENABLERS classic

All Ecosmart Classic Systems must include at least one enabler.
(N.B. when used, BMS control and time clocks take over all other enablers).



ES-PIR2 (Enabler)
Detects movement and activates system. Incorporates a system status LED, overrun timer and timer adjustment.



ES-TEMP2 TEMPERATURE (Sensor)
Modulate fan speed based on room temperature. Incorporates two system status LEDs. (Green = OK, Red = Failure) and temperature set point level adjustment.



ES-THERMOSTAT2 (Enabler)
Activates the system when the temperature is above set point. Incorporates two system status LEDs. (Green = OK, Red = Failure) and temperature set point level adjustment.



ES-RH2 RELATIVE HUMIDITY (Sensor)
Modulate fan speed based on RH level. Incorporates two system status LEDs. (Green = OK, Red = Failure) and RH set point level adjustment.



ES-AV12 (Enabler)
When fan failure occurs the AVI will flash a warning. Supplied with pre-plugged 10m length of communication cable.



ES-CI SEMI-AUTOMATIC USER CONTROL
Fan, heating & cooling selected by external volt free switch, speed selected by 0-10V signal.



ES-HUMIDISTAT2 (Enabler)
Activates the system when the RH level is above set point. Incorporates two system status LEDs. (Green = OK, Red = Failure) and RH set point level adjustment.



ES-JB JUNCTION BOX
Designed to be compatible with Ecosmart System this unit is supplied with a pre-plugged 10 metre length of communications cable and has 8 further ports.



ES-CO2RM (Sensor)
ES-CO2RMPP (Sensor)
Surface mounted room carbon dioxide (CO₂) sensors incorporate a temperature sensor. RM = SELV option, RMPP complete with SELV AC powers supply.



ES-CO2 (Sensor)
Duct mounted sensor to modulate fan speed based on CO₂ levels. Connect to fan directly. Pre-wired with 2m cable (not adjustable).



ES-HTCSIG (Enabler)
Signal conditioning circuit for humidity, temperature and CO₂ sensors.



SWITCHED LIVE (by others)
Any mains voltage signal connected to the switched live terminal (S/L) in the unit. This affects the connected fan only.

ecosmart ROOM MODULES CONNECT



ESCO-TPL
Ecosmart Connect Room Module - Temperature and PIR.



ESCO-THS
Ecosmart Connect Room Module - Temperature and Humidity.



ESCO-TDPL
Ecosmart Connect Room Module - Temperature, Display and PIR.



ESCO-TDHL
Ecosmart Connect Room Module - Temperature, Display and Humidity. (Displays either temperature or humidity).



ESCO-TDHS
Ecosmart Connect Room Module - Temperature, Display and Humidity. (Humidity is not displayed).

TOUCH SCREENS & MANUAL USER CONTROLS



ES-LCD (Enabler) Touch screen user control in white incorporating time clock facility. This can control the function of the fan by manual setting or using a set of timed programs.



ES-UCF Manual 'on' and 'off' system user/speed control. Incorporates two system status LEDs (Green = OK, Red = Failure).



ESCO-LCD Touch screen display. The ESC-LCD is a user friendly operator interface featuring BACnet® communication and a colourful, graphic display with touch-screen interface. It is powered by 12-24VAC / VDC.

ECOSMART CONTROL PLATFORM - IT'S SO SMART IT'S SIMPLE



ESCO-TDS
Ecosmart Connect Room Module - Temperature and Display.



ESCO-TS
Ecosmart Connect Room Module - Temperature.



ESCO-CL
Ecosmart Connect Room Module - CO2.



ESCO-TDFS
Ecosmart Connect Room Module - Temperature, Display and Fan Speed Override.



ESCO-THPL
Ecosmart Connect Room Module - Temperature, Humidity and PIR.



ESCO-IPN
The BACnet IP to MS/TP Router exchanges information between networks and allows the controller to communicate on an IP network. One router is required for each MS/TP network.

THERMISTOR TEMPERATURE SENSORS



Code: TB/T1/S – For duct or immersion use. Short 150mm.
TB/T1/L – For duct use only. Long 400mm

Low cost thermistor sensors comprising insertion, clamp-on, and outside air versions. The insertion sensor may be used for duct or immersion purposes. It has a 6 mm diameter brass probe which is suitable for retrofit immersion applications and will fit most existing pockets (universal fitting kit option).

FEATURES

- Low cost
- High quality thermistors
- Brass probes
- M20 conduit entry with M16 cable gland
- IP67 housing
- Quarter turn quick release lid
- Easy to wire
- Universal kit option for retrofit of immersion sensors
- Adjustable insertion depth flange option for duct sensors

DUCT HUMIDITY & TEMPERATURE SENSORS



Code: HT/D – Duct and thermistor sensor (+/-3%).

Duct mounted relative humidity and temperature sensors for HVAC applications. The certified 2% high accuracy (/2%) and standard 3% versions offer excellent linearity and stability over a wide humidity range (10 to 90 %RH).

FEATURES

- Pre-calibrated for ease of commissioning
- IP65
- Operates over 10 to 100 %RH non-condensing
- ± 3% accuracy versions
- 2 part connectors for ease of installation
- Humidity sensor element protected by replaceable filter
- Capacitive humidity sensing element provides excellent long term stability
- Adjustable depth duct mounting flange option

CO2 SENSORS



Code: CO2/T/D – Duct sensor.
Code: CO2/T/S – Space carbon dioxide concentration and temperature sensor.

The CO2 duct and space sensors monitor the carbon dioxide concentration and temperature of the air. The space sensors have additional options of humidity monitoring and a 4 digit display. The display will show the measured values in succession. The duct sensor has a quick-release lid to facilitate installation.

FEATURES

- Low cost, high quality thermistor temperature sensor
- Humidity monitoring option for space sensor
- Optional digital display for space sensor
- IP67 housing (duct sensor)
- Quarter turn quick release lid (duct sensor)
- Two part terminals to facilitate wiring
- 24 Vac/dc supply
- Adjustable depth duct mounting flange option



IQVIEW4 Touch screen display. (6 x 4 inch). FPK/Plate – Mounting plate.
IQVIEW4/SM BOX – Surface mount box for wall or panel.
Transformer for IQVIEW4 included.
ACC/24V - 230/24 VAC, 36 VA



IQVIEW8 Touch screen display. (10 x 6 inch). IQVIEW8/SM BOX – Surface mount box for flat surfaces.
Transformer for IQVIEW8 included.
ACC/24V – 230/24 VAC, 36 VA



SDU Display. RD/SDU-IQ2COMMSCABLE/3m – RJ11 plug to RJ11 plug cable (3m) for SDU.

PRODUCT SELECTION

NUAIRE'S CUSTOMERS ARE INVOLVED IN THE DEVELOPMENT OF EVERY TYPE OF EDUCATIONAL ENVIRONMENT WITH VARYING COMPLEXITY INCLUDING THE DEVELOPMENT OF NEW BUILD AND REFURBISHMENT PROJECTS IN LIVE ENVIRONMENTS



NUAIRE'S CUSTOMERS CREATE INSPIRATIONAL LEARNING ENVIRONMENTS AND HELP FACILITATE MAJOR CHANGES IN EDUCATIONAL SPACES.

Nuaire assists its customers to deliver their projects and to keep within their project programme, quality and cost.

Over the years Nuaire's knowledge and understanding of current government education legislation has grown significantly.

The Priority School Building Programme (PSBP) Facilities Output Specification launched by the Education Funding Agency (EFA) has proposed some significant, positive and welcome changes to school ventilation specifications. To find out more visit: www.gov.uk/government/collections/priority-school-building-programme-psbp.

We understand the many challenges and regulations that modern building ventilation must meet... and our technical team are on hand to assist with product selections.

Building Information Modelling (BIM) is both a new technology and a new way of working. BIM is a term that has been around for a while in manufacturing and engineering industries, and is now beginning to make an impact in the construction sector.



Nuaire has a dedicated BIM Team offering libraries of Revit® compatible BIM models to meet customers' exact specification.

Nuaire's libraries offer collision detection through geometry, connection positions and weights. Project specific performance criteria and support for design, project management and building operations can be requested which will result in improved design efficiency.

To download Nuaire's Revit® compatible BIM models simply visit www.nuaire.co.uk/BIM and click on the library. Alternatively, simply email the team BIM@nuaire.co.uk with your request.



Scan here for BIM Library.

COMPLYING WITH BUILDING REGULATIONS

The following information is relevant to the selection of fans for Ventilation Systems, indicating the maximum specific fan powers allowed under Part L (Refer to the Non-domestic Building Services Compliance Guide: 2013 Edition for further details).



The SFP for the entire system (including both supply & extract fans) shall be less than that allowed by these figures. The following tables are the maximum values allowed under Building Regulations when finally commissioned.

| Air distribution system | Specific fan power (W/(l/s)) | |
|---|------------------------------|--------------------|
| | New Buildings | Existing Buildings |
| Central balanced mechanical ventilation system with heating and cooling | 1.6 | 2.2 |
| Central balanced mechanical ventilation system with heating only | 1.5 | 1.8 |
| All other central balanced mechanical ventilation systems | 1.1 | 1.6 |
| Zonal supply system where the fan is remote from the zone, such as ceiling void or roof mounted units | 1.1 | 1.4 |
| Zonal extract system where fan is remote from zone | 0.5 | 0.5 |
| Zonal supply and extract ventilation system such as ceiling void or roof units serving a single room or zone with heating and heat recovery | 1.9 | 1.9 |
| Local balanced supply and extract ventilation system / such as wall roof units serving a single area with heating and heat recovery | 1.6 | 1.6 |
| Local supply or extract ventilation units such as window / wall / roof units serving a single area (e.g. toilet extract) | 0.3 | 0.4 |
| Other local ventilation supply or extract units | 0.5 | 0.5 |
| Fan assisted terminal (VAV) unit | 1.1 | 1.1 |
| Fan coil units (rating weighted average*) | 0.5 | 0.5 |
| Kitchen extract, fan remote from zone with grease filter | 1.0 | 1.0 |

*Note: The weighted average is calculated by the following formula:

$$\frac{P_{\text{mains},1} \times \text{SFP}_1 + P_{\text{mains},2} \times \text{SFP}_2 + P_{\text{mains},3} \times \text{SFP}_3 + \dots}{P_{\text{mains},1} + P_{\text{mains},2} + P_{\text{mains},3} + \dots}$$
 where P_{mains} is useful power supplied from the mains in W

| Extending SFP for additional components in new and existing buildings | |
|---|-----------------|
| Component | (SFP (W/(l/s))) |
| Additional return filter for heat recovery | +0.1 |
| HEPA filter | +1.0 |
| Heat recovery - thermal wheel system | +0.3 |
| Heat recovery - other systems | +0.3 |
| Humidifier / dehumidifier (air conditioning system) | +0.1 |

Example: For a central mechanical ventilation system with heating and cooling, and heat recovery via a plate heat exchanger plus return filter:

$$\text{SFP} = 1.6 + 0.3 + 0.1 \text{ W/(l/s)} = 2.0 \text{ W/(l/s)}$$

| Recommended minimum dry heat recovery efficiency for heat exchangers in new and existing buildings | |
|--|------------------------------|
| Heat exchanger type | Dry Heat recovery efficiency |
| Plate heat exchanger | 50% |
| Heat pipes | 60% |
| Thermal wheel | 65% |
| Run around coil | 45% |

SECTION 6 (2015 EDITION)

Permissible maximum specific fan power and pressure drop in air distribution systems.



Maximum specific fan powers in air distribution systems new and existing buildings.

| System type | Specific fan power (W/(l/s)) | |
|---|------------------------------|--------------------|
| | New Buildings | Existing Buildings |
| Central balanced mechanical ventilation system with heating and cooling | 1.6 | 2.2 |
| Central balanced mechanical ventilation system with heating only | 1.5 | 1.8 |
| All other central balanced mechanical ventilation systems | 1.1 | 1.6 |
| Zonal supply system where fan is remote from the zone, such as ceiling void or roof mounted units | 1.1 | 1.4 |
| Zonal extract system where fan is remote from zone | 0.5 | 0.5 |
| Zonal supply and extract ventilation units, such as ceiling void or roof units serving single room or zone with heating and heat recovery | 1.9 | 1.9 |
| Local balanced supply and extract ventilation system such as wall/ roof units serving single area with heat recovery | 1.6 | 1.6 |
| Local supply or extract ventilation units such as window/ wall/ roof units serving single area (e.g. toilet extract) | 0.3 | 0.4 |
| Other local ventilation supply or extract units | 0.5 | 0.5 |
| Fan assisted terminal VAV unit | 1.1 | 1.1 |
| Fan coil unit (rating weighted average*) | 0.5 | 0.5 |
| Kitchen extract, fan remote from zone with grease filter | 1.0 | 1.0 |

*The weighted average is calculated by the following formula:

$$\frac{P_{\text{mains},1} \times \text{SFP}_1 + P_{\text{mains},2} \times \text{SFP}_2 + P_{\text{mains},3} \times \text{SFP}_3 + \dots}{P_{\text{mains},1} + P_{\text{mains},2} + P_{\text{mains},3} + \dots}$$
 where P_{mains} is useful power supplied from the mains in W

| Extending SFP for additional components in new and existing buildings | |
|---|---------------|
| Component | SFP (W/(l/s)) |
| Additional return filter for heat recovery | +0.1 |
| HEPA filter | +1.0 |
| Heat recovery – thermal wheel system | +0.3 |
| Heat recovery – other systems | +0.3 |
| Humidifier/ dehumidifier (air conditioning system) | +0.1 |

Recommended minimum dry heat recovery efficiency for heat exchangers in new and existing buildings

| Heat exchanger type | Dry heat recovery efficiency |
|----------------------|------------------------------|
| Plate heat exchanger | 50% |
| Heat pipes | 60% |
| Thermal wheel | 65% |
| Run around coil | 45% |

XBC10 HORIZONTAL HEAT EXCHANGE UNITS

PERFORMANCE & TECHNICAL INFORMATION

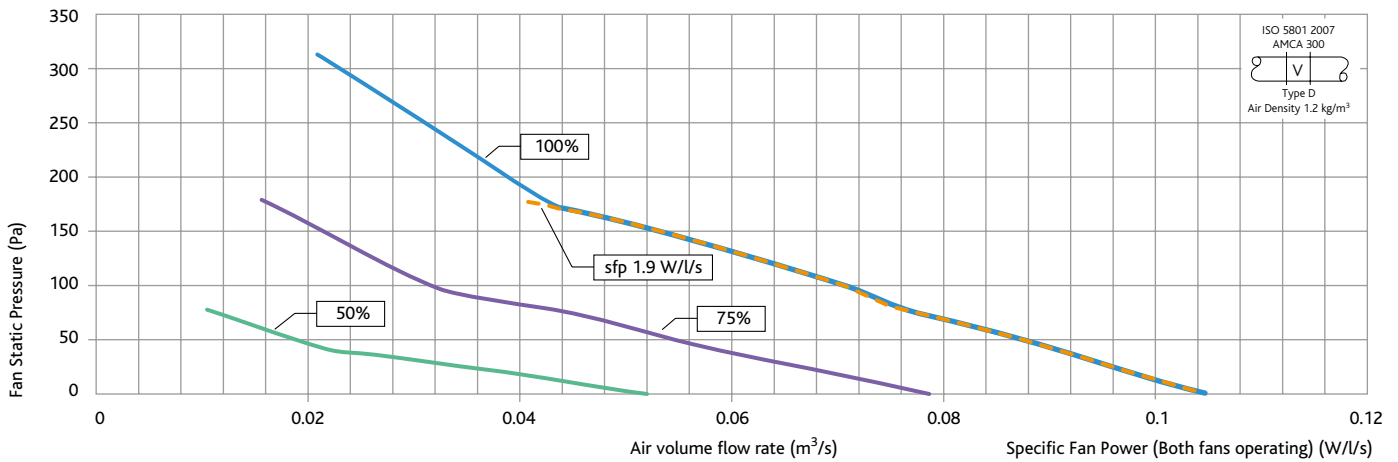

XBC10 UNIT PERFORMANCE

| Fan Speed | External Static Pressure (Pa) | Fan Speed | | | | | Fan Speed | External Static Pressure (Pa) | Fan Speed | | | | | |
|-----------|-------------------------------|-----------|-------|-------|-------|-------|-----------|-------------------------------|-----------|-------|-------|-----|-----|--|
| | | 0 | 50 | 100 | 200 | 300 | | | 0 | 50 | 100 | 200 | 300 | |
| 100% | Airflow (m³/s) | 0.105 | 0.088 | 0.070 | 0.039 | 0.023 | 50% | Airflow (m³/s) | 0.052 | 0.020 | 0.003 | | | |
| | sfp (W/l/s) | 0.786 | 0.938 | 1.179 | 2.115 | 3.587 | | sfp (W/l/s) | 0.288 | 0.750 | 5.000 | | | |
| | dBa@3m | 24 | | | | | | dBa@3m | < 20 | | | | | |
| 75% | Airflow (m³/s) | 0.078 | 0.055 | 0.032 | 0.010 | | | | | | | | | |
| | sfp (W/l/s) | 0.449 | 0.636 | 1.094 | 3.500 | | | | | | | | | |
| | dBa@3m | <20 | | | | | | | | | | | | |

Specific Fan Power figures are the total for both fans operating.

For accurate figures, please refer to Nuair Fan Selection Programme at www.nuair.co.uk

| Unit Code | Voltage / Phase / Frequency | Input Power (W) | FLC / SC (A) | Max Operating Temperature | Fan Speed (rpm) | Unit Weight (kg) | Packed Weight (kg) | Pallet / crate dimensions (mm) |
|-------------|-----------------------------|-----------------|--------------|---------------------------|-----------------|------------------|--------------------|--------------------------------|
| XBC10-H-L** | 230 / 1 / 50 | 160 | 1.5 / 1.5 | 40°C | 3200 | 147 | 197 | 1850L x 1400W x 505H |
| XBC10-H-E** | 230 / 1 / 50 | 160 | 9 / 9 | 40°C | 3200 | 155 | 205 | 1850L x 1400W x 505H |
| XBC10-H-N** | 230 / 1 / 50 | 160 | 1.5 / 1.5 | 40°C | 3200 | 143 | 193 | 1850L x 1400W x 505H |

**Add relevant code ie: BC, ES, CO or AT for control type. *Includes 1.5kW Electric Heater.

FAN UNIT DIMENSIONS (mm)

Note: All models (BC, ES, CO or AT) have a fold down (90°) pivoting control box for easy commissioning.

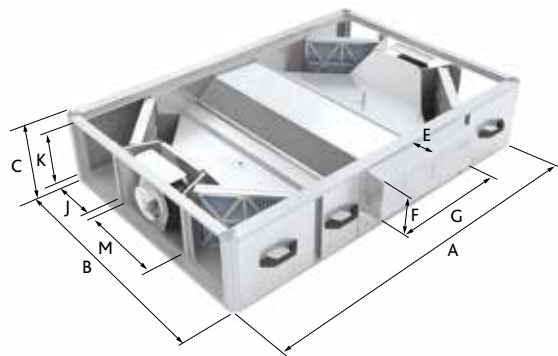

XBC10 FAN CONFIGURATION

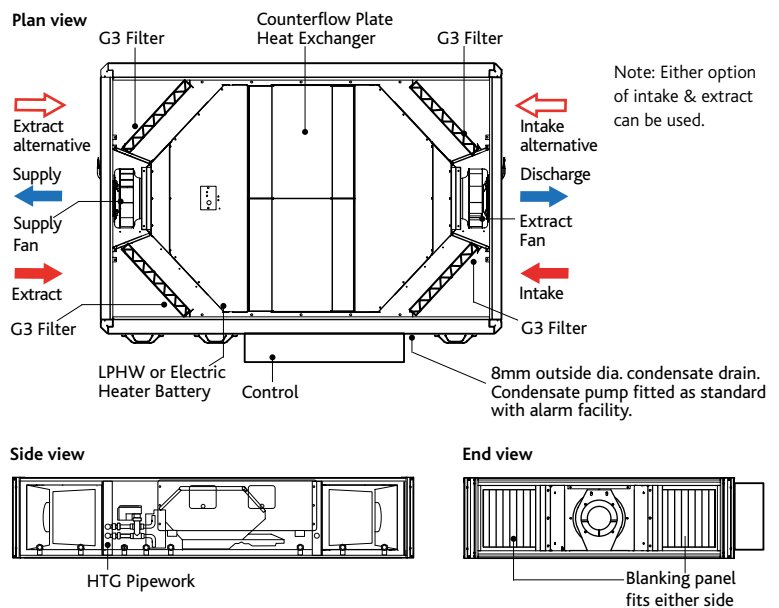

| Fan Unit Dimensions (mm) | | | Control for all Models Dimensions (mm) | | | Rectangular Aperture Dimensions (mm) | | | Weather Roof for Code XBC10-H-WP | | | Service & Maintenance Requirements | | |
|--------------------------|------|-----|--|-----|-----|--------------------------------------|-----|-----|----------------------------------|------|------|------------------------------------|---|---|
| A | B | C | E | F | G | J | K | M | H | x | W | | x | L |
| 1600 | 1000 | 260 | 120 | 200 | 670 | 238 | 220 | 347 | 65 | 1000 | 1900 | | | |

The unit is designed for side access as standard and must be installed with a minimum of 260mm clearance from a wall or barrier. This will provide access to filters, coil, fan, heat exchanger, condensate tray and pump.

2 attenuator flanges are attached to every unit. Add 50mm to dimension 'A' to include both flanges. Weather roof is separate code and can be retro fitted on site.

XBC10 HORIZONTAL HEAT EXCHANGE UNITS

PERFORMANCE & TECHNICAL INFORMATION

XBC10 FAN - SOUND DATA

| Fan Speed | Sound Power Levels (dB re 1 pW) | Frequency (Hz) | | | | | | | | Spherical dBA@3m | Fan Speed | External Static Pressure (Pa) | | | | | | | | Spherical dBA@3m |
|-----------|---------------------------------|----------------|-----|-----|-----|------|------|------|------|------------------|-----------|-------------------------------|-----|-----|-----|------|------|------|------|------------------|
| | | 63 | 125 | 250 | 500 | 1000 | 2000 | 4000 | 8000 | | | 63 | 125 | 250 | 500 | 1000 | 2000 | 4000 | 8000 | |
| 100% | Induct Intake | 68 | 57 | 50 | 51 | 57 | 50 | 42 | 38 | 24 | 50% | 53 | 42 | 35 | 36 | 42 | 35 | 27 | 23 | <20 |
| | Induct Supply | 73 | 69 | 60 | 61 | 63 | 59 | 54 | 52 | | | 58 | 54 | 45 | 46 | 48 | 44 | 39 | 37 | |
| | Induct Discharge | 73 | 70 | 60 | 62 | 63 | 60 | 55 | 53 | | | 58 | 55 | 45 | 47 | 48 | 45 | 40 | 38 | |
| | Induct Extract | 67 | 56 | 50 | 50 | 56 | 50 | 40 | 36 | | | 52 | 41 | 35 | 35 | 41 | 35 | 25 | 21 | |
| | Casing Radiated | 59 | 55 | 40 | 41 | 39 | 35 | 32 | 21 | | | 44 | 40 | 25 | 26 | 24 | 20 | <20 | <20 | |
| 75% | Induct Intake | 62 | 51 | 44 | 45 | 51 | 44 | 36 | 32 | 20 | | | | | | | | | | |
| | Induct Supply | 67 | 63 | 54 | 55 | 57 | 53 | 48 | 46 | | | | | | | | | | | |
| | Induct Discharge | 67 | 64 | 54 | 56 | 57 | 54 | 49 | 47 | | | | | | | | | | | |
| | Induct Extract | 61 | 50 | 44 | 44 | 50 | 44 | 34 | 30 | | | | | | | | | | | |
| | Casing Radiated | 53 | 49 | 34 | 35 | 33 | 29 | 26 | <20 | | | | | | | | | | | |

*Casing Radiated (Breakout).

ATTENUATOR DIMENSIONS (mm), DYNAMIC INSERTION LOSS (dB) & WEIGHTS (kg)

| Attenuator Code | Attenuator Dimensions | | | | Air path | Dynamic Insertion Loss (dB) | | | | | | | | Attenuator Weight (kg) | Packed Weight (kg) |
|-----------------|-----------------------|-------|--------|-------|----------|-----------------------------|-----|-----|------|------|------|------|----|------------------------|--------------------|
| | Length | Width | Height | 63 | | 125 | 250 | 500 | 1000 | 2000 | 4000 | 8000 | | | |
| XBC15-HS-MS10 | 1050 | 351 | 218 | S / D | 5 | 11 | 12 | 19 | 27 | 28 | 24 | 19 | 33 | 38 | |
| XBC15-HE-MS10 | 1050 | 242 | 218 | I / E | 2 | 2 | 3 | 10 | 17 | 10 | 6 | 3 | 29 | 32 | |
| XBC15-HS-MS12 | 1250 | 351 | 218 | S / D | 7 | 13 | 16 | 26 | 35 | 34 | 27 | 21 | 40 | 45 | |
| XBC15-HE-MS12 | 1250 | 242 | 218 | I / E | 4 | 4 | 7 | 17 | 25 | 16 | 9 | 5 | 34 | 37 | |
| XBC15-HS-MS16 | 1600 | 351 | 218 | S / D | 9 | 15 | 20 | 33 | 41 | 40 | 30 | 23 | 49 | 54 | |
| XBC15-HE-MS16 | 1600 | 242 | 218 | I / E | 6 | 6 | 11 | 24 | 31 | 22 | 12 | 7 | 42 | 45 | |

S / D = Supply / Discharge I / E = Intake / Extract. Coding: The S / D denotes the type of silencer required for the supply or discharge. The I / E denotes the type of silencer required for the extract or fresh air intake on the unit. All XBC matched silencers are double skinned.

COUNTERFLOW HEAT EXCHANGER EFFICIENCY (%)

Performance based on:
Indoor Conditions 21 Deg C / 50 % RH

Key to performance curves

- Intake Temperature (Deg C)
- 5 Deg C Intake Typically Specified Values
- 3 Deg C Intake Typically Specified Values
- 1 Deg C Intake Typically Specified Values
- 6 Deg C Approx. Average outdoor temperature (UK heating season)

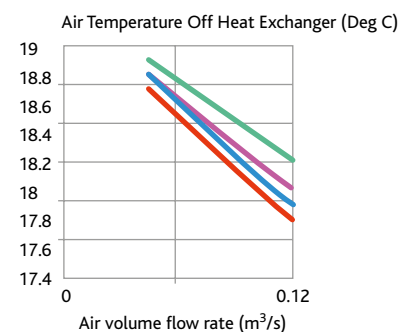
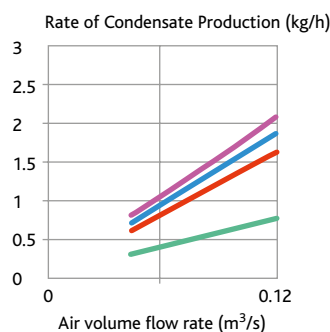
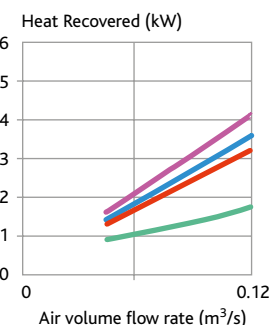
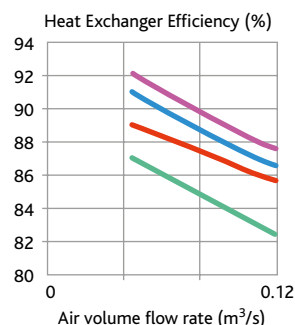

HEATING COIL DATA LPHW

| LPHW Deg C | Airflow (m³/s) | Output (kW) | Air Off Temp (C*) | Water flow (l/s) | Coil ΔP (kPa) | Pipe Connection (mm) | Valve ΔP (kPa) | Valve Type |
|------------|----------------|-------------|-------------------|------------------|---------------|----------------------|----------------|------------|
| LPHW 82/71 | 0.09 | 3.0 | 38 | 0.07 | 1.0 | 15 | 1.4 | 4 Port |
| LPHW 80/60 | 0.09 | 2.3 | 32 | 0.03 | 0.2 | 15 | 0.5 | 4 Port |
| LPHW 60/40 | 0.09 | 1.3 | 22 | 0.02 | 0.1 | 15 | 0.5 | 4 Port |

*Nb Limited to 30 Deg C for Ecosmart Units. Data based on 10 Deg C Air On temperature.

XBC15 HORIZONTAL HEAT EXCHANGE UNITS

PERFORMANCE & TECHNICAL INFORMATION

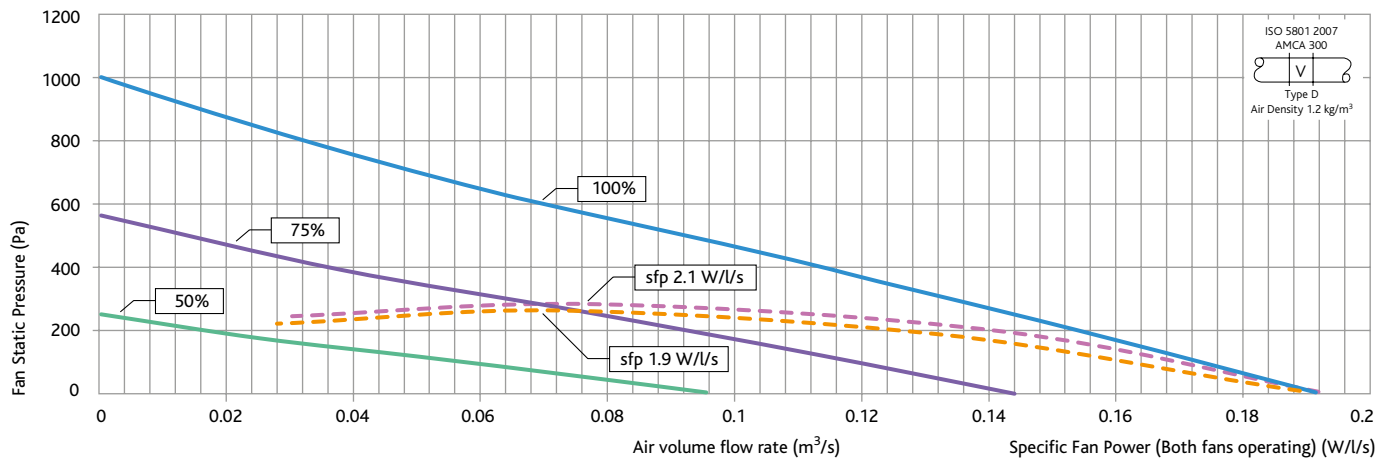

XBC15 UNIT PERFORMANCE - EXAMPLE 0.1m³/s @ 100Pa = SFP 1.1, 17dBA @ 3m

| Fan Speed | External Static Pressure (Pa) | Fan Speed | | | | | | | | | Fan Speed | External Static Pressure (Pa) | | | | | | | | | | | | |
|-----------|-------------------------------|-----------|------|------|------|------|------|------|------|------|-----------|-------------------------------|------|-----------------------------|------|------|-----|-----|-----|-----|-----|--|--|--|
| | | 0 | 50 | 100 | 200 | 300 | 400 | 500 | 600 | 700 | | | 0 | 50 | 100 | 200 | 300 | 400 | 500 | 600 | 700 | | | |
| 100% | Airflow (m ³ /s) | 0.19 | 0.18 | 0.17 | 0.15 | 0.13 | 0.11 | 0.09 | 0.07 | 0.05 | 50% | Airflow (m ³ /s) | 0.10 | 0.08 | 0.06 | 0.02 | | | | | | | | |
| | sfp (W/l/s) | 1.80 | 1.82 | 1.88 | 2.13 | 2.55 | 3.15 | 3.92 | 4.87 | 5.99 | | sfp (W/l/s) | 0.45 | 0.53 | 0.79 | 1.82 | | | | | | | | |
| | dBA@3m | 26 | | | | | | | | | | dBA@3m | < 20 | | | | | | | | | | | |
| 75% | Airflow (m ³ /s) | 0.14 | 0.13 | 0.12 | 0.09 | 0.06 | 0.04 | 0.01 | | | | | 25% | Airflow (m ³ /s) | 0.05 | 0.01 | | | | | | | | |
| | sfp (W/l/s) | 1.01 | 1.05 | 1.16 | 1.61 | 2.37 | 3.45 | 4.83 | | | | | | sfp (W/l/s) | 0.11 | 0.46 | | | | | | | | |
| | dBA@3m | 20 | | | | | | | | | dBA@3m | < 20 | | | | | | | | | | | | |

Specific Fan Power figures are the total for both fans operating.

For accurate figures, please refer to Nuair Fan Selection Programme at www.nuair.co.uk

| Unit Code | Voltage / Phase / Frequency | Input Power (W) | FLC / SC (A) | Max Operating Temperature | Fan Speed (rpm) | Unit Weight (kg) | Packed Weight (kg) | Pallet / crate dimensions (mm) |
|-------------|-----------------------------|-----------------|--------------|---------------------------|-----------------|------------------|--------------------|--------------------------------|
| XBC15-H-L** | 230 / 1 / 50 | 340 | 2.8 / 2.8 | 40°C | 4000 | 187 | 237 | 1850L x 1400W x 505H |
| XBC15-H-E** | 230 / 1 / 50 | 3340* | 16 / 16 | 40°C | 4000 | 195 | 245 | 1850L x 1400W x 505H |
| XBC15-H-N** | 230 / 1 / 50 | 340 | 2.8 / 2.8 | 40°C | 4000 | 183 | 233 | 1850L x 1400W x 505H |

**Add relevant code ie: BC, ES, CO or AT for control type. *Includes 3kW Electric Heater.

FAN UNIT DIMENSIONS (mm)

Note: All models (BC, ES, CO or AT) have a fold down (90°) pivoting control box for easy commissioning.

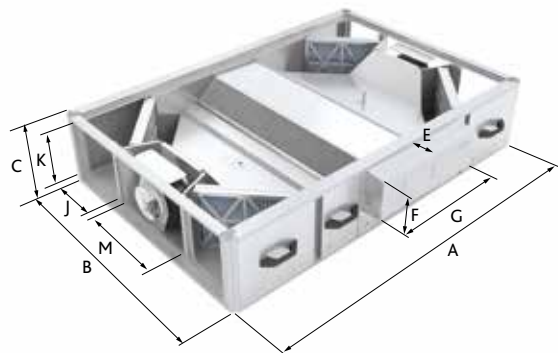

XBC15 FAN CONFIGURATION

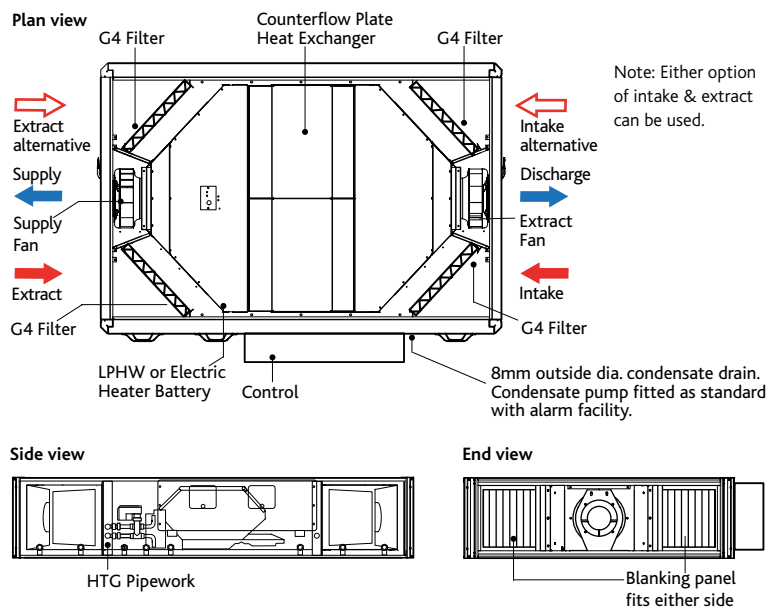

| Fan Unit Dimensions (mm) | | | Control for all Models Dimensions (mm) | | | Rectangular Aperture Dimensions (mm) | | | Weather Roof for Code XBC15-H-WP | | | Service & Maintenance Requirements | | |
|--------------------------|------|-----|--|-----|-----|--------------------------------------|-----|-----|----------------------------------|------|------|--|---|--|
| A | B | C | E | F | G | J | K | M | H | x | W | x | L | |
| 1600 | 1000 | 260 | 120 | 200 | 670 | 238 | 220 | 347 | 65 | 1000 | 1900 | The unit is designed for side access as standard and must be installed with a minimum of 260mm clearance from a wall or barrier. This will provide access to filters, coil, fan, heat exchanger, condensate tray and pump. | | |

2 attenuator flanges are attached to every unit. Add 50mm to dimension 'A' to include both flanges. Weather roof is separate code and can be retro fitted on site.

XBC15 HORIZONTAL HEAT EXCHANGE UNITS

PERFORMANCE & TECHNICAL INFORMATION

XBC15 FAN - SOUND DATA

| Fan Speed | Sound Power Levels (dB re 1 pW) | Frequency (Hz) | | | | | | | | Spherical dBA@3m | Fan Speed | External Static Pressure (Pa) | | | | | | | | Spherical dBA@3m |
|-----------|---------------------------------|----------------|-----|-----|-----|------|------|------|------|------------------|-----------|-------------------------------|-----|-----|-----|------|------|------|------|------------------|
| | | 63 | 125 | 250 | 500 | 1000 | 2000 | 4000 | 8000 | | | 63 | 125 | 250 | 500 | 1000 | 2000 | 4000 | 8000 | |
| 100% | Induct Intake | 70 | 60 | 55 | 56 | 62 | 55 | 47 | 43 | 26 | 50% | 55 | 45 | 40 | 41 | 47 | 40 | 32 | 28 | <20 |
| | Induct Supply | 75 | 72 | 65 | 66 | 68 | 64 | 59 | 57 | | | 60 | 57 | 50 | 51 | 53 | 49 | 44 | 42 | |
| | Induct Discharge | 75 | 73 | 65 | 67 | 68 | 65 | 60 | 58 | | | 60 | 58 | 50 | 52 | 53 | 50 | 45 | 43 | |
| | Induct Extract | 69 | 59 | 55 | 55 | 61 | 55 | 45 | 41 | | | 54 | 44 | 40 | 40 | 46 | 40 | 30 | 26 | |
| | Casing Radiated | 61 | 57 | 42 | 43 | 41 | 37 | 34 | 23 | | | 46 | 42 | 27 | 28 | 26 | 22 | >20 | >20 | |
| 75% | Induct Intake | 64 | 54 | 49 | 50 | 56 | 49 | 41 | 37 | 20 | 25% | 40 | 30 | 25 | 26 | 32 | 25 | 17 | 13 | <20 |
| | Induct Supply | 69 | 66 | 59 | 60 | 62 | 58 | 53 | 51 | | | 45 | 42 | 35 | 36 | 38 | 34 | 29 | 27 | |
| | Induct Discharge | 69 | 67 | 59 | 61 | 62 | 59 | 54 | 52 | | | 45 | 43 | 35 | 37 | 38 | 35 | 30 | 28 | |
| | Induct Extract | 63 | 53 | 49 | 49 | 55 | 49 | 39 | 35 | | | 39 | 29 | 25 | 25 | 31 | 25 | >20 | >20 | |
| | Casing Radiated | 55 | 51 | 36 | 37 | 35 | 31 | 28 | >20 | | | 31 | 27 | >20 | >20 | >20 | >20 | >20 | >20 | |

*Casing Radiated (Breakout).

ATTENUATOR DIMENSIONS (mm), DYNAMIC INSERTION LOSS (dB) & WEIGHTS (kg)

| Attenuator Code | Attenuator Dimensions | | | | Air path | Dynamic Insertion Loss (dB) | | | | | | | | Attenuator Weight (kg) | Packed Weight (kg) |
|-----------------|-----------------------|-------|--------|-------|----------|-----------------------------|-----|-----|------|------|------|------|----|------------------------|--------------------|
| | Length | Width | Height | 63 | | 125 | 250 | 500 | 1000 | 2000 | 4000 | 8000 | | | |
| XBC15-HS-MS10 | 1050 | 351 | 218 | S / D | 5 | 11 | 12 | 19 | 27 | 28 | 24 | 19 | 33 | 38 | |
| XBC15-HE-MS10 | 1050 | 242 | 218 | I / E | 2 | 2 | 3 | 10 | 17 | 10 | 6 | 3 | 29 | 32 | |
| XBC15-HS-MS12 | 1250 | 351 | 218 | S / D | 7 | 13 | 16 | 26 | 35 | 34 | 27 | 21 | 40 | 45 | |
| XBC15-HE-MS12 | 1250 | 242 | 218 | I / E | 4 | 4 | 7 | 17 | 25 | 16 | 9 | 5 | 34 | 37 | |
| XBC15-HS-MS16 | 1600 | 351 | 218 | S / D | 9 | 15 | 20 | 33 | 41 | 40 | 30 | 23 | 49 | 54 | |
| XBC15-HE-MS16 | 1600 | 242 | 218 | I / E | 6 | 6 | 11 | 24 | 31 | 22 | 12 | 7 | 42 | 45 | |

S / D = Supply / Discharge I / E = Intake / Extract. Coding: The S / D denotes the type of silencer required for the supply or discharge. The I / E denotes the type of silencer required for the extract or fresh air intake on the unit. All XBC matched silencers are double skinned.

COUNTERFLOW HEAT EXCHANGER EFFICIENCY (%)

Performance based on:
Indoor Conditions 21 Deg C / 50 % RH

Key to performance curves

- Intake Temperature (Deg C)
- 5 Deg C Intake Typically Specified Values
- 3 Deg C Intake Typically Specified Values
- 1 Deg C Intake Typically Specified Values
- 6 Deg C Approx. Average outdoor temperature (UK heating season)

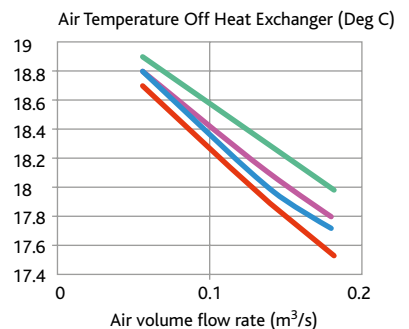
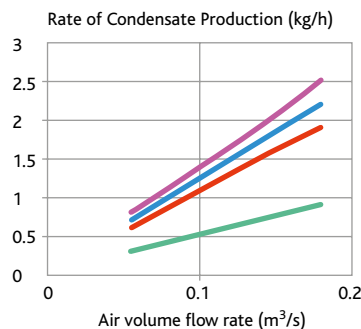
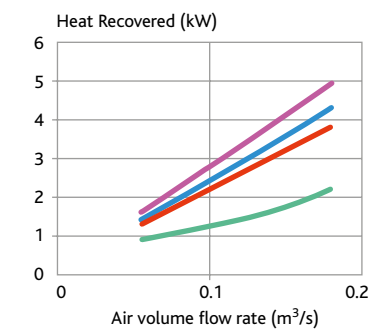
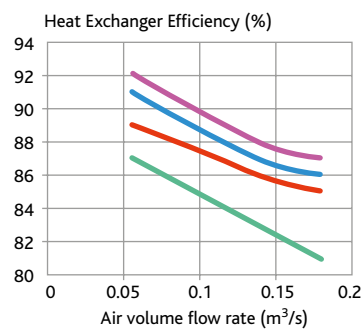

HEATING COIL DATA LPHW

| LPHW Deg C | Airflow (m³/s) | Output (kW) | Air Off Temp (C*) | Water flow (l/s) | Coil ΔP (kPa) | Pipe Connection (mm) | Valve ΔP (kPa) | Valve Type |
|------------|----------------|-------------|-------------------|------------------|---------------|----------------------|----------------|------------|
| LPHW 82/71 | 0.17 | 4.1 | 30 | 0.09 | 1.8 | 15 | 2.5 | 4 Port |
| | 0.13 | 3.9 | 35 | 0.08 | 1.6 | 15 | 2.2 | |
| | 0.09 | 3.0 | 38 | 0.07 | 1.0 | 15 | 1.4 | |
| LPHW 80/60 | 0.17 | 3.3 | 26 | 0.04 | 0.4 | 15 | 1 | 4 Port |
| | 0.13 | 3.0 | 29 | 0.04 | 0.3 | 15 | 0.9 | |
| | 0.09 | 2.3 | 32 | 0.03 | 0.2 | 15 | 0.5 | |
| LPHW 60/40 | 0.17 | 1.9 | 19 | 0.02 | 0.1 | 15 | 1 | 4 Port |
| | 0.13 | 1.7 | 21 | 0.02 | 0.1 | 15 | 0.8 | |
| | 0.09 | 1.3 | 22 | 0.02 | 0.1 | 15 | 0.5 | |

*Nb Limited to 30 Deg C for Ecosmart Units. Data based on 10 Deg C Air On temperature.

XBC25 HORIZONTAL HEAT EXCHANGE UNITS

PERFORMANCE & TECHNICAL INFORMATION

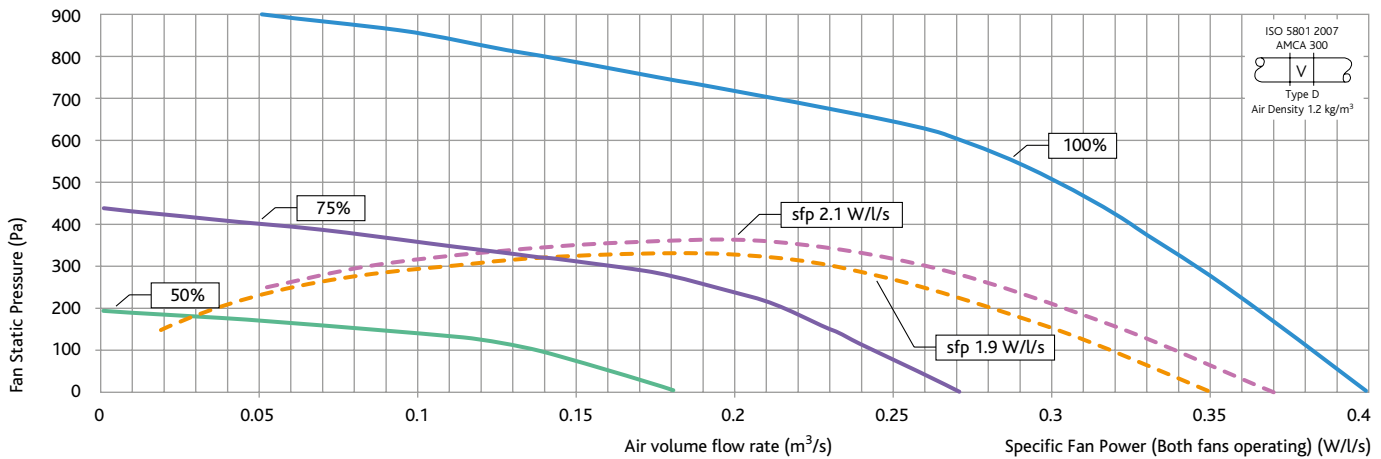

XBC25 UNIT PERFORMANCE - EXAMPLE 0.2m³/s @ 150Pa = SFP 1.1, 29dBA @ 3m

| Fan Speed | External Static Pressure (Pa) | External Static Pressure (Pa) | | | | | | | Fan Speed | External Static Pressure (Pa) | External Static Pressure (Pa) | | | | | | | | | |
|-----------|-------------------------------|-------------------------------|------|------|------|------|------|------|-----------|-------------------------------|-------------------------------|------|------|------|-----|-----|-----|-----|-----|-----|
| | | 0 | 50 | 100 | 200 | 300 | 400 | 500 | | | 600 | 700 | 0 | 50 | 100 | 200 | 300 | 400 | 500 | 600 |
| 100% | Airflow (m ³ /s) | 0.36 | 0.35 | 0.34 | 0.32 | 0.30 | 0.27 | 0.24 | 0.17 | 50% | Airflow (m ³ /s) | 0.18 | 0.16 | 0.14 | | | | | | |
| | sfp (W/l/s) | 2.00 | 2.10 | 2.15 | 2.28 | 2.46 | 2.59 | 2.90 | 3.80 | | sfp (W/l/s) | 0.5 | 0.57 | 0.65 | | | | | | |
| | dBA@3m | 37 | | | | | | | dBA@3m | | 25 | | | | | | | | | |
| 75% | Airflow (m ³ /s) | 0.27 | 0.26 | 0.24 | 0.21 | 0.16 | 0.05 | | | 25% | Airflow (m ³ /s) | 0.09 | | | | | | | | |
| | sfp (W/l/s) | 1.1 | 1.2 | 1.3 | 1.4 | 1.7 | 4 | | | | sfp (W/l/s) | 0.2 | | | | | | | | |
| | dBA@3m | 31 | | | | | | | dBA@3m | | < 20 | | | | | | | | | |

Specific Fan Power figures are the total for both fans operating.

For accurate figures, please refer to Nuair Fan Selection Programme at www.nuair.co.uk

| Unit Code | Voltage / Phase / Frequency | Input Power (W) | FLC / SC (A) | Max Operating Temperature | Fan Speed (rpm) | Unit Weight (kg) | Packed Weight (kg) | Pallet / crate dimensions (mm) |
|-------------|-----------------------------|-----------------|--------------|---------------------------|-----------------|------------------|--------------------|--------------------------------|
| XBC25-H-L** | 230 / 1 / 50 | 1000 | 6.4 / 6.4 | 40°C | 4000 | 235 | 285 | 1850L x 1400W x 505H |
| XBC25-H-E** | 230 / 1 / 50 | 5500* | 19.4 / 19.4 | 40°C | 4000 | 242 | 292 | 1850L x 1400W x 505H |
| XBC25-H-N** | 230 / 1 / 50 | 1000 | 6.4 / 6.4 | 40°C | 4000 | 231 | 281 | 1850L x 1400W x 505H |

**Add relevant code ie: BC, ES, CO or AT for control type. *Includes 4.5kW Electric Heater.

FAN UNIT DIMENSIONS (mm)

Note: All models (BC, ES, CO or AT) have a fold down (90°) pivoting control box for easy commissioning.

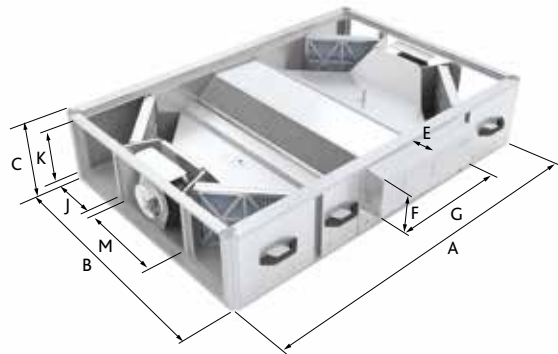

XBC25 FAN CONFIGURATION

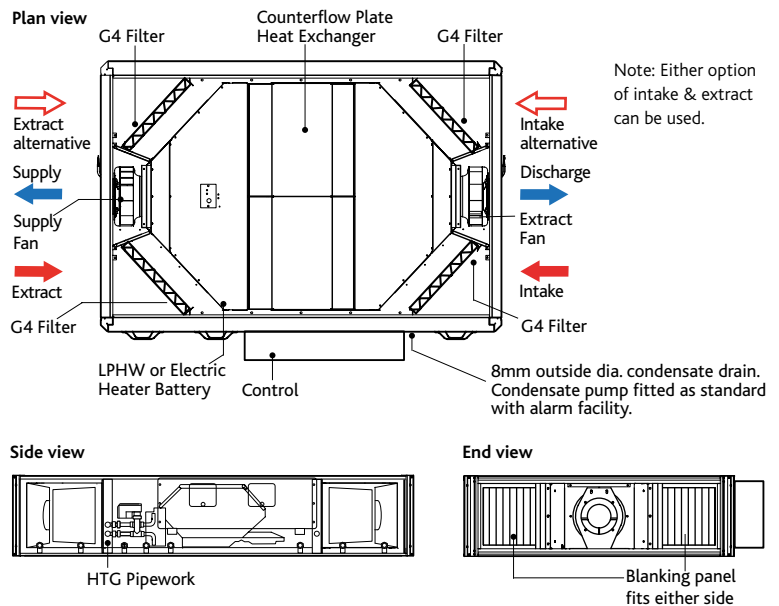

| Fan Unit Dimensions (mm) | | | Control for all Models Dimensions (mm) | | | Rectangular Aperture Dimensions (mm) | | | Weather Roof for Code XBC25-H-WP | | | Service & Maintenance Requirements | | |
|--------------------------|------|-----|--|-----|-----|--------------------------------------|-----|-----|----------------------------------|------|------|------------------------------------|---|--|
| A | B | C | E | F | G | J | K | M | H | x | W | x | L | The unit is designed for side access as standard and must be installed with a minimum of 260mm clearance from a wall or barrier. This will provide access to filters, coil, fan, heat exchanger, condensate tray and pump. |
| 1700 | 1150 | 340 | 120 | 200 | 670 | 252 | 302 | 471 | 75 | 1150 | 2000 | | | |

2 attenuator flanges are attached to every unit. Add 50mm to dimension 'A' to include both flanges. Weather roof is separate code and can be retro fitted on site.

XBC25 HORIZONTAL HEAT EXCHANGE UNITS

PERFORMANCE & TECHNICAL INFORMATION

XBC25 FAN - SOUND DATA

| Fan Speed | Sound Power Levels (dB re 1 pW) | Frequency (Hz) | | | | | | | | Spherical dBA@3m | Fan Speed | External Static Pressure (Pa) | | | | | | | | Spherical dBA@3m |
|-----------|---------------------------------|----------------|-----|-----|-----|------|------|------|------|------------------|-----------|-------------------------------|-----|------|------|------|------|------|------|------------------|
| | | 63 | 125 | 250 | 500 | 1000 | 2000 | 4000 | 8000 | | | 63 | 125 | 250 | 500 | 1000 | 2000 | 4000 | 8000 | |
| 100% | Induct Intake | 77 | 71 | 69 | 71 | 66 | 62 | 54 | 53 | 37 | 50% | 63 | 57 | 55 | 57 | 52 | 48 | 40 | 39 | 23 |
| | Induct Supply | 82 | 83 | 78 | 82 | 72 | 72 | 68 | 70 | | | 68 | 69 | 64 | 68 | 58 | 58 | 54 | 56 | |
| | Induct Discharge | 83 | 84 | 78 | 81 | 72 | 72 | 70 | 71 | | | 69 | 70 | 64 | 67 | 58 | 58 | 56 | 57 | |
| | Induct Extract | 76 | 70 | 68 | 71 | 65 | 62 | 54 | 54 | | | 62 | 56 | 54 | 57 | 51 | 48 | 40 | 40 | |
| | Casing Radiated | 69 | 68 | 55 | 58 | 45 | 44 | 44 | 36 | | | 55 | 54 | 41 | 44 | 31 | 30 | 30 | 22 | |
| 75% | Induct Intake | 71 | 65 | 63 | 65 | 60 | 56 | 48 | 47 | 31 | 25% | 48 | 42 | 40 | 42 | 37 | 33 | 25 | 24 | < 20 |
| | Induct Supply | 76 | 77 | 72 | 76 | 66 | 66 | 62 | 64 | | | 53 | 54 | 49 | 53 | 43 | 43 | 39 | 41 | |
| | Induct Discharge | 77 | 78 | 72 | 75 | 66 | 66 | 64 | 65 | | | 54 | 55 | 49 | 52 | 43 | 43 | 41 | 42 | |
| | Induct Extract | 70 | 64 | 62 | 65 | 59 | 56 | 48 | 48 | | | 47 | 41 | 39 | 42 | 36 | 33 | 25 | 25 | |
| | Casing Radiated | 63 | 62 | 49 | 52 | 39 | 38 | 38 | 30 | 40 | 39 | 26 | 29 | < 20 | < 20 | < 20 | < 20 | | | |

*Casing Radiated (Breakout).

ATTENUATOR DIMENSIONS (mm), DYNAMIC INSERTION LOSS (dB) & WEIGHTS (kg)

| Attenuator Code | Attenuator Dimensions | | | Air path | Dynamic Insertion Loss (dB) | | | | | | | | Attenuator Weight (kg) | Packed Weight (kg) |
|-----------------|-----------------------|-------|--------|----------|-----------------------------|-----|-----|-----|------|------|------|------|------------------------|--------------------|
| | Length | Width | Height | | 63 | 125 | 250 | 500 | 1000 | 2000 | 4000 | 8000 | | |
| XBC25-HS-MS10 | 1050 | 481 | 298 | S / D | 5 | 8 | 15 | 30 | 41 | 31 | 21 | 16 | 42 | 47 |
| XBC25-HE-MS10 | 1050 | 262 | 298 | I / E | 4 | 4 | 10 | 22 | 26 | 15 | 10 | 8 | 33 | 36 |
| XBC25-HS-MS12 | 1250 | 481 | 298 | S / D | 7 | 10 | 18 | 36 | 51 | 39 | 26 | 20 | 51 | 56 |
| XBC25-HE-MS12 | 1250 | 262 | 298 | I / E | 5 | 6 | 12 | 27 | 34 | 20 | 13 | 9 | 40 | 43 |
| XBC25-HS-MS16 | 1600 | 481 | 298 | S / D | 9 | 13 | 23 | 42 | 55 | 49 | 32 | 25 | 64 | 69 |
| XBC25-HE-MS16 | 1600 | 262 | 298 | I / E | 6 | 8 | 15 | 33 | 43 | 25 | 15 | 11 | 50 | 53 |

S / D = Supply / Discharge I / E = Intake / Extract. Coding: The S / D denotes the type of silencer required for the supply or discharge. The I / E denotes the type of silencer required for the extract or fresh air intake on the unit. All XBC matched silencers are double skinned.

COUNTERFLOW HEAT EXCHANGER EFFICIENCY (%)

Performance based on:
Indoor Conditions 21 Deg C / 50 % RH

Key to performance curves

- Intake Temperature (Deg C)
- 5 Deg C Intake Typically Specified Values
- 3 Deg C Intake Typically Specified Values
- 1 Deg C Intake Typically Specified Values
- 6 Deg C Approx. Average outdoor temperature (UK heating season)

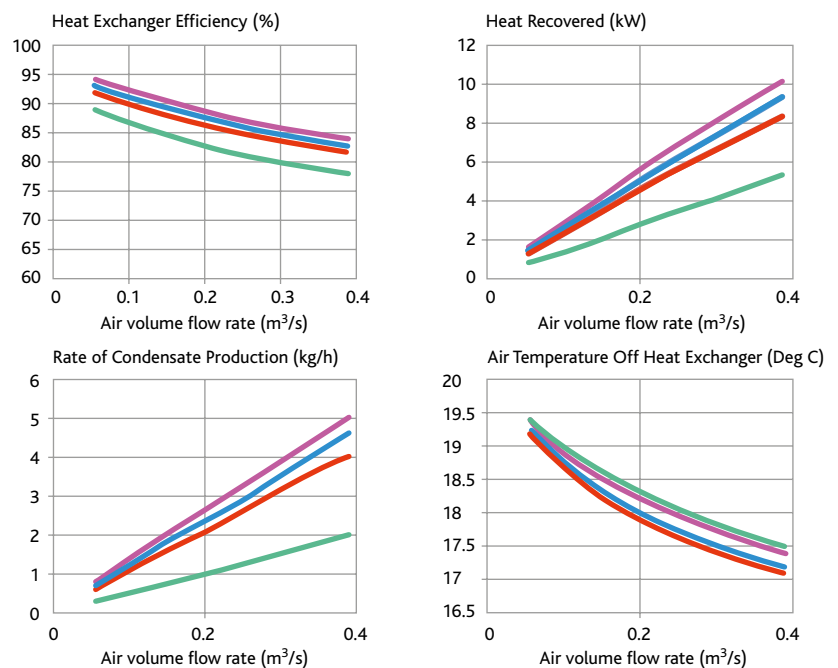

HEATING COIL DATA LPHW

| LPHW Deg C | Airflow (m³/s) | Output (kW) | Air Off Temp (C*) | Water flow (l/s) | Coil ΔP (kPa) | Pipe Connection (mm) | Valve ΔP (kPa) | Valve Type |
|------------|----------------|-------------|-------------------|------------------|---------------|----------------------|----------------|------------|
| LPHW 82/71 | 0.25 | 6.0 | 30 | 0.13 | 7.3 | 15 | 9 | 4 Port |
| | 0.1875 | 5.6 | 35 | 0.13 | 6.5 | 15 | 8.0 | |
| | 0.125 | 4.4 | 40 | 0.10 | 4.0 | 15 | 4.9 | |
| LPHW 80/60 | 0.25 | 4.8 | 26 | 0.06 | 1.4 | 15 | 2 | 4 Port |
| | 0.1875 | 4.3 | 29 | 0.05 | 1.3 | 15 | 1.8 | |
| | 0.125 | 3.4 | 33 | 0.04 | 0.8 | 15 | 1.1 | |
| LPHW 60/40 | 0.25 | 2.8 | 19 | 0.03 | 0.5 | 15 | 1 | 4 Port |
| | 0.1875 | 2.6 | 21 | 0.03 | 0.4 | 15 | 0.8 | |
| | 0.125 | 2.0 | 23 | 0.02 | 0.3 | 15 | 0.5 | |

*Nb Limited to 30 Deg C for Ecosmart Units. Data based on 10 Deg C Air On temperature.

XBC45 HORIZONTAL HEAT EXCHANGE UNITS

PERFORMANCE & TECHNICAL INFORMATION

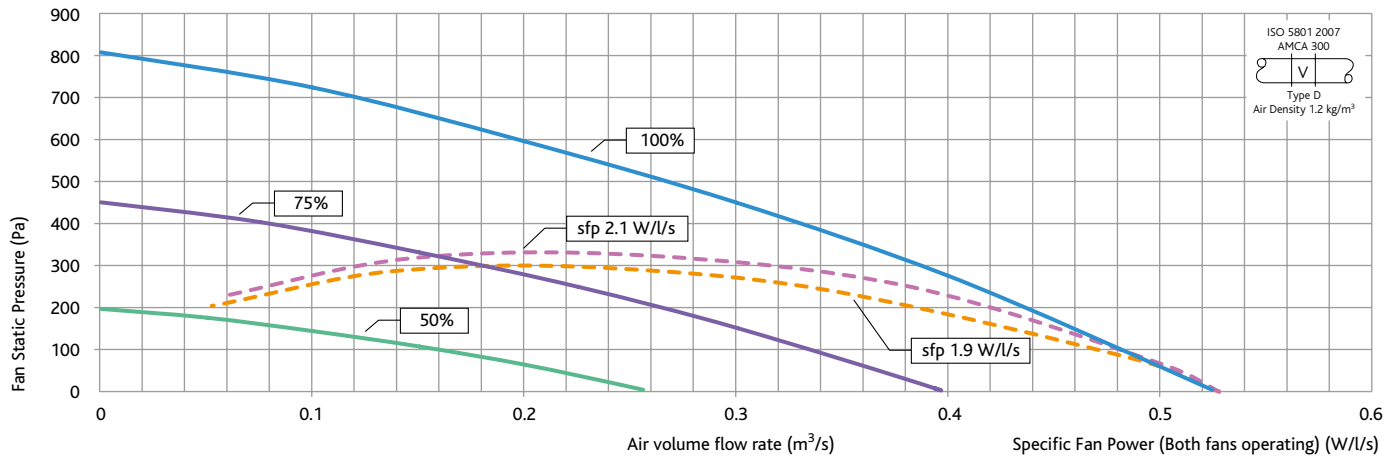

XBC45 UNIT PERFORMANCE - EXAMPLE 0.256m³/s @ 150Pa = SFP 1.1, 27dBA @ 3m

| Fan Speed | External Static Pressure (Pa) | Fan Speed | | | | | | | | | Fan Speed | External Static Pressure (Pa) | | | | | | | | | |
|-----------|-------------------------------|-----------|------|------|------|------|------|------|------|-------------|-----------|-------------------------------|------|----------------|------|------|-----|-----|-----|-----|-----|
| | | 0 | 50 | 100 | 200 | 300 | 400 | 500 | 600 | 700 | | | 0 | 50 | 100 | 200 | 300 | 400 | 500 | 600 | 700 |
| 100% | Airflow (m³/s) | 0.53 | 0.50 | 0.48 | 0.44 | 0.39 | 0.33 | 0.27 | 0.20 | 0.12 | 50% | Airflow (m³/s) | 0.26 | 0.22 | 0.17 | 0.01 | | | | | |
| | sfp (W/l/s) | 1.75 | 1.83 | 1.95 | 2.21 | 2.42 | 2.64 | 3.04 | 3.95 | sfp (W/l/s) | | 0.44 | 0.55 | 0.66 | 2.35 | | | | | | |
| | dBA@3m | 35 | | | | | | | | | | dBA@3m | 20 | | | | | | | | |
| 75% | Airflow (m³/s) | 0.39 | 0.37 | 0.34 | 0.27 | 0.19 | 0.08 | | | | | | 25% | Airflow (m³/s) | 0.13 | 0.00 | | | | | |
| | sfp (W/l/s) | 0.98 | 1.08 | 1.21 | 1.43 | 1.85 | 3.51 | | | | | | | sfp (W/l/s) | 0.11 | 0.59 | | | | | |
| | dBA@3m | 29 | | | | | | | | | dBA@3m | < 20 | | | | | | | | | |

Specific Fan Power figures are the total for both fans operating.

For accurate figures, please refer to Nuair Fan Selection Programme at www.nuair.co.uk

| Unit Code | Voltage / Phase / Frequency | | Input Power (W) | FLC / SC (A) | | Max Operating Temperature | Fan Speed (rpm) | Unit Weight (kg) | Packed Weight (kg) | Pallet / crate dimensions (mm) |
|-------------|-----------------------------|----------|-----------------|--------------|-------|---------------------------|-----------------|------------------|--------------------|--------------------------------|
| | | | | | | | | | | |
| XBC45-H-L** | 230 | / 1 / 50 | 1100 | 6.9 | / 6.9 | 40°C | 2400 | 291 | 391 | 2150L x 1800W x 650H |
| XBC45-H-E** | 230 | / 1 / 50 | 5600* | 27 | / 27 | 40°C | 2400 | 298 | 398 | 2150L x 1800W x 650H |
| XBC45-H-N** | 230 | / 1 / 50 | 1100 | 6.9 | / 6.9 | 40°C | 2400 | 287 | 387 | 2150L x 1800W x 650H |

**Add relevant code ie: BC, ES, CO or AT for control type. *Includes 4.5kW Electric Heater.

FAN UNIT DIMENSIONS (mm)

Note: All models (BC, ES, CO or AT) have a fold down (90°) pivoting control box for easy commissioning.

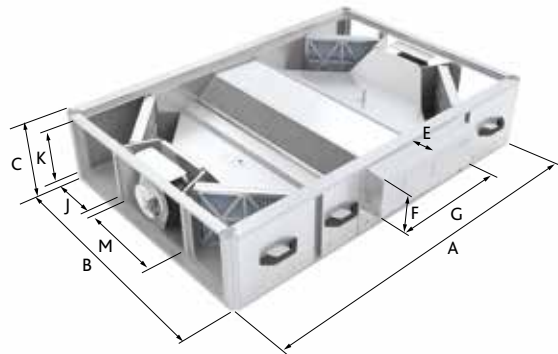

XBC45 FAN CONFIGURATION

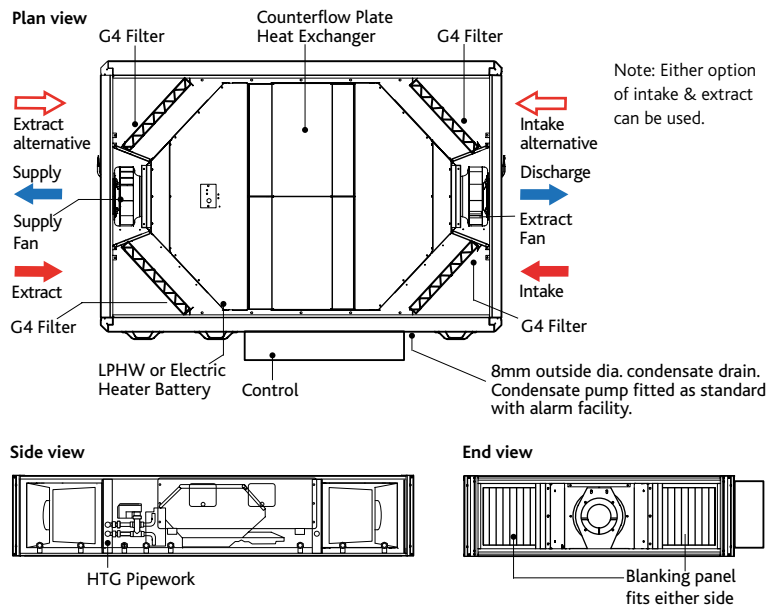

| Fan Unit Dimensions (mm) | | | Control for all Models Dimensions (mm) | | | Rectangular Aperture Dimensions (mm) | | | Weather roof for Code XBC45-H-WP | | | Service & Maintenance Requirements | |
|--------------------------|------|-----|--|-----|-----|--------------------------------------|-----|-----|----------------------------------|------|------|--|---|
| A | B | C | E | F | G | J | K | M | H | x | W | | x |
| 1900 | 1250 | 400 | 120 | 200 | 670 | 270 | 360 | 531 | 85 | 1250 | 2200 | The unit is designed for side access as standard and must be installed with a minimum of 260mm clearance from a wall or barrier. This will provide access to filters, coil, fan, heat exchanger, condensate tray and pump. | |

2 attenuator flanges are attached to every unit. Add 50mm to dimension 'A' to include both flanges. Weather roof is separate code and can be retro fitted on site.

XBC45 HORIZONTAL HEAT EXCHANGE UNITS

PERFORMANCE & TECHNICAL INFORMATION

XBC45 FAN - SOUND DATA

| Fan Speed | Sound Power Levels (dB re 1 pW) | Frequency (Hz) | | | | | | | | Spherical dBA@3m | Fan Speed | External Static Pressure (Pa) | | | | | | | | Spherical dBA@3m |
|-----------|---------------------------------|----------------|-----|-----|-----|------|------|------|------|------------------|-----------|-------------------------------|-----|-----|------|------|------|------|------|------------------|
| | | 63 | 125 | 250 | 500 | 1000 | 2000 | 4000 | 8000 | | | 63 | 125 | 250 | 500 | 1000 | 2000 | 4000 | 8000 | |
| 100% | Induct Intake | 83 | 75 | 75 | 64 | 64 | 62 | 54 | 45 | 35 | 50% | 68 | 60 | 60 | 49 | 49 | 47 | 39 | 30 | 20 |
| | Induct Supply | 87 | 80 | 85 | 71 | 72 | 71 | 66 | 62 | | | 72 | 65 | 70 | 56 | 57 | 56 | 51 | 47 | |
| | Induct Discharge | 88 | 81 | 85 | 71 | 72 | 72 | 66 | 64 | | | 73 | 66 | 70 | 56 | 57 | 57 | 51 | 49 | |
| | Induct Extract | 84 | 75 | 76 | 63 | 64 | 63 | 53 | 44 | | | 69 | 60 | 61 | 48 | 49 | 48 | 38 | 29 | |
| | Casing Radiated | 74 | 65 | 62 | 47 | 45 | 44 | 40 | 29 | | | 59 | 50 | 47 | 32 | 30 | 29 | 25 | < 20 | |
| 75% | Induct Intake | 77 | 69 | 69 | 58 | 58 | 56 | 48 | 39 | 29 | 25% | 53 | 45 | 45 | 34 | 34 | 32 | 24 | < 20 | < 20 |
| | Induct Supply | 81 | 74 | 79 | 65 | 66 | 65 | 60 | 56 | | | 57 | 50 | 55 | 41 | 42 | 41 | 36 | 32 | |
| | Induct Discharge | 82 | 75 | 79 | 65 | 66 | 66 | 60 | 58 | | | 58 | 51 | 55 | 41 | 42 | 42 | 36 | 34 | |
| | Induct Extract | 78 | 69 | 70 | 57 | 58 | 57 | 47 | 38 | | | 54 | 45 | 46 | 33 | 34 | 33 | 23 | < 20 | |
| | Casing Radiated | 68 | 59 | 56 | 41 | 39 | 38 | 34 | 23 | | | 44 | 35 | 32 | < 20 | < 20 | < 20 | < 20 | < 20 | |

*Casing Radiated (Breakout).

ATTENUATOR DIMENSIONS (mm), DYNAMIC INSERTION LOSS (dB) & WEIGHTS (kg)

| Attenuator Code | Attenuator Dimensions | | | Air path | Dynamic Insertion Loss (dB) | | | | | | | | Attenuator Weight (kg) | Packed Weight (kg) |
|-----------------|-----------------------|-------|--------|----------|-----------------------------|-----|-----|-----|------|------|------|------|------------------------|--------------------|
| | Length | Width | Height | | 63 | 125 | 250 | 500 | 1000 | 2000 | 4000 | 8000 | | |
| XBC45-HS-MS10 | 1050 | 536 | 358 | S / D | 5 | 9 | 16 | 13 | 11 | 8 | 7 | 6 | 48 | 53 |
| XBC45-HE-MS10 | 1050 | 275 | 358 | I / E | 3 | 5 | 11 | 13 | 15 | 11 | 6 | 4 | 37 | 40 |
| XBC45-HS-MS12 | 1250 | 536 | 358 | S / D | 7 | 11 | 20 | 20 | 19 | 14 | 10 | 8 | 59 | 64 |
| XBC45-HE-MS12 | 1250 | 275 | 358 | I / E | 5 | 7 | 15 | 20 | 23 | 17 | 9 | 6 | 45 | 48 |
| XBC45-HS-MS16 | 1600 | 536 | 358 | S / D | 9 | 13 | 24 | 27 | 25 | 20 | 13 | 10 | 73 | 78 |
| XBC45-HE-MS16 | 1600 | 275 | 358 | I / E | 7 | 9 | 19 | 27 | 29 | 23 | 12 | 8 | 56 | 59 |

S / D = Supply / Discharge I / E = Intake / Extract. Coding: The S / D denotes the type of silencer required for the supply or discharge. The I / E denotes the type of silencer required for the extract or fresh air intake on the unit. All XBC matched silencers are double skinned.

COUNTERFLOW HEAT EXCHANGER EFFICIENCY (%)

Performance based on:
Indoor Conditions 21 Deg C / 50 % RH

Key to performance curves

- Intake Temperature (Deg C)
- 5 Deg C Intake Typically Specified Values
- 3 Deg C Intake Typically Specified Values
- 1 Deg C Intake Typically Specified Values
- 6 Deg C Approx. Average outdoor temperature (UK heating season)

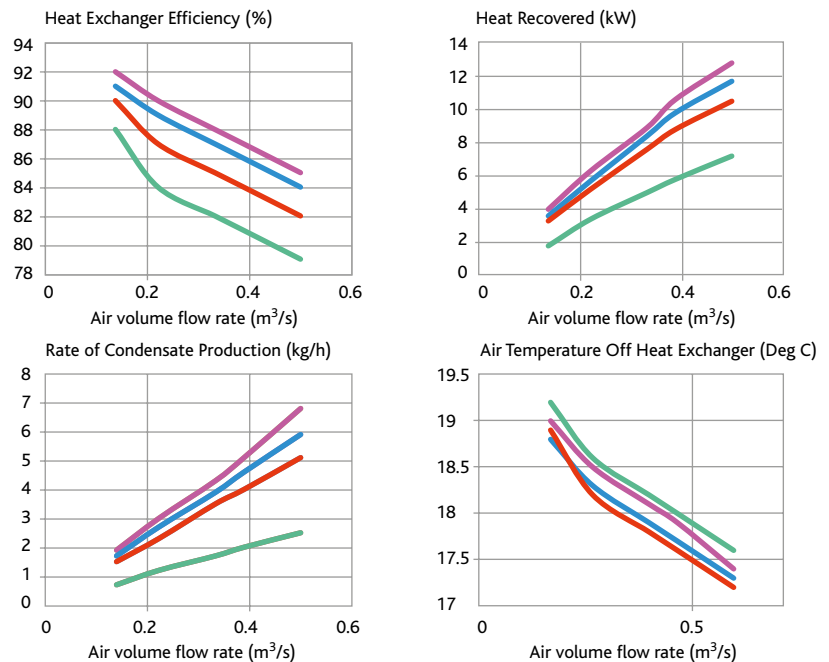

HEATING COIL DATA LPHW

| LPHW Deg C | Airflow (m³/s) | Output (kW) | Air Off Temp (C*) | Water flow (l/s) | Coil ΔP (kPa) | Pipe Connection (mm) | Valve ΔP (kPa) | Valve Type |
|------------|----------------|-------------|-------------------|------------------|---------------|----------------------|----------------|------------|
| LPHW 82/71 | 0.37 | 8.9 | 30 | 0.20 | 16.0 | 15 | 16 | 4 Port |
| | 0.2775 | 8.4 | 35 | 0.19 | 14.1 | 15 | 14.1 | |
| | 0.185 | 6.6 | 40 | 0.15 | 8.8 | 15 | 8.8 | |
| LPHW 80/60 | 0.37 | 7.2 | 26 | 0.09 | 3.2 | 15 | 3 | 4 Port |
| | 0.2775 | 6.5 | 29 | 0.08 | 2.8 | 15 | 2.7 | |
| | 0.185 | 5.1 | 33 | 0.06 | 1.8 | 15 | 1.6 | |
| LPHW 60/40 | 0.37 | 4.2 | 19 | 0.05 | 1.0 | 15 | 1 | 4 Port |
| | 0.2775 | 3.9 | 22 | 0.05 | 0.8 | 15 | 0.8 | |
| | 0.185 | 3.0 | 23 | 0.04 | 0.5 | 15 | 0.5 | |

*Nb Limited to 30 Deg C for Ecosmart Units. Data based on 10 Deg C Air On temperature.

XBC55 HORIZONTAL HEAT EXCHANGE UNITS

PERFORMANCE & TECHNICAL INFORMATION

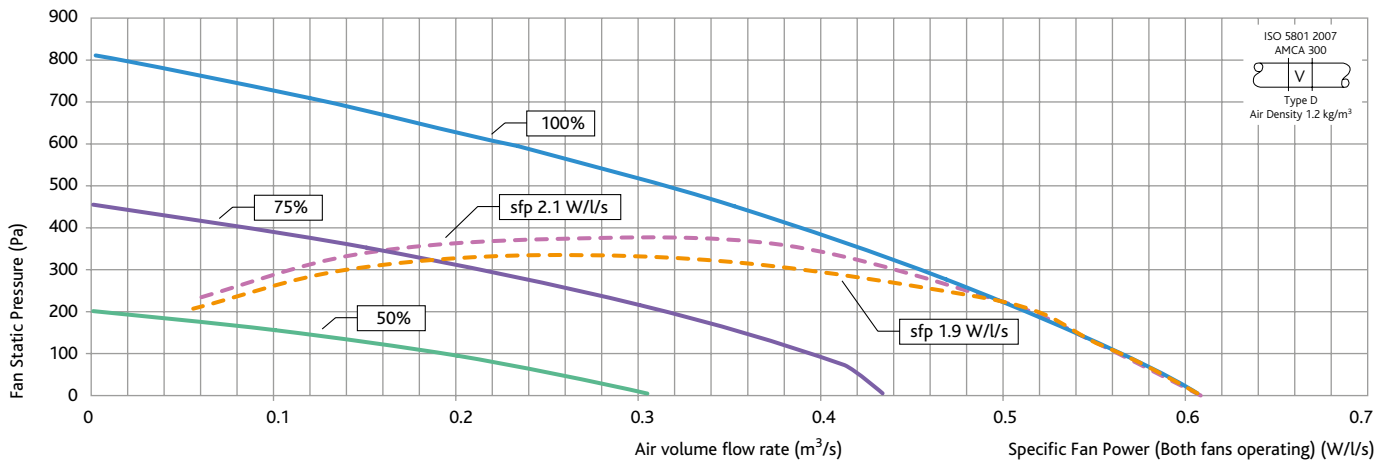

XBC55 UNIT PERFORMANCE - EXAMPLE 0.38m³/s @ 150Pa = SFP 1.2, 29dBA @ 3m

| Fan Speed | External Static Pressure (Pa) | Fan Speed | | | | | | | | | Fan Speed | External Static Pressure (Pa) | | | | | | | | | | | |
|-----------|-------------------------------|-----------|------|------|------|------|------|------|------|------|-----------|-------------------------------|------|-----------------------------|------|------|-----|-----|-----|-----|-----|--|--|
| | | 0 | 50 | 100 | 200 | 300 | 400 | 500 | 600 | 700 | | | 0 | 50 | 100 | 200 | 300 | 400 | 500 | 600 | 700 | | |
| 100% | Airflow (m ³ /s) | 0.61 | 0.59 | 0.57 | 0.51 | 0.46 | 0.39 | 0.31 | 0.23 | 0.13 | 50% | Airflow (m ³ /s) | 0.31 | 0.26 | 0.20 | 0.01 | | | | | | | |
| | sfp (W/l/s) | 1.60 | 1.64 | 1.69 | 1.82 | 2.03 | 2.38 | 2.91 | 3.67 | 4.71 | | sfp (W/l/s) | 0.40 | 0.45 | 0.59 | 1.52 | | | | | | | |
| | dBA@3m | 35 | | | | | | | | | | dBA@3m | 20 | | | | | | | | | | |
| 75% | Airflow (m ³ /s) | 0.46 | 0.43 | 0.39 | 0.32 | 0.21 | 0.09 | | | | | | 25% | Airflow (m ³ /s) | 0.15 | 0.00 | | | | | | | |
| | sfp (W/l/s) | 0.90 | 0.95 | 1.00 | 1.24 | 1.76 | 2.72 | | | | | | | sfp (W/l/s) | 0.10 | 0.38 | | | | | | | |
| | dBA@3m | 28 | | | | | | | | | dBA@3m | < 20 | | | | | | | | | | | |

Specific Fan Power figures are the total for both fans operating.

For accurate figures, please refer to Nuair Fan Selection Programme at www.nuair.co.uk

| Unit Code | Voltage / Phase / Frequency | Input Power (W) | FLC / SC (A) | Max Operating Temperature | Fan Speed (rpm) | Unit Weight (kg) | Packed Weight (kg) | Pallet / crate dimensions (mm) |
|-------------|-----------------------------|-----------------|--------------|---------------------------|-----------------|------------------|--------------------|--------------------------------|
| XBC55-H-L** | 230 / 1 / 50 | 1100 | 6.9 / 6.9 | 40°C | 2400 | 368 | 468 | 2150L x 1500W x 650H |
| XBC55-H-E** | 230 / 1 / 50 | 10100* | 46 / 46 | 40°C | 2400 | 375 | 475 | 2150L x 1500W x 650H |
| XBC55-H-N** | 230 / 1 / 50 | 1100 | 6.9 / 6.9 | 40°C | 2400 | 364 | 464 | 2150L x 1500W x 650H |

**Add relevant code ie: BC, ES, CO or AT for control type. *Includes 9kW Electric Heater.

FAN UNIT DIMENSIONS (mm)

Note: All models (BC, ES, CO or AT) have a fold down (90°) pivoting control box for easy commissioning.

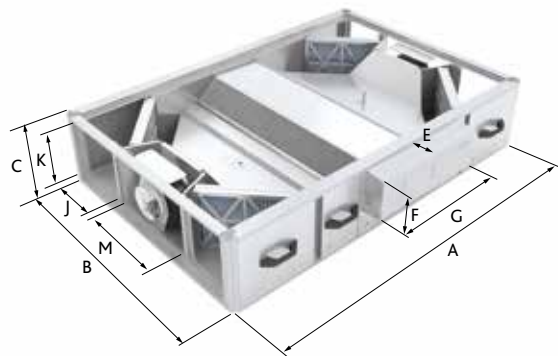

XBC55 FAN CONFIGURATION

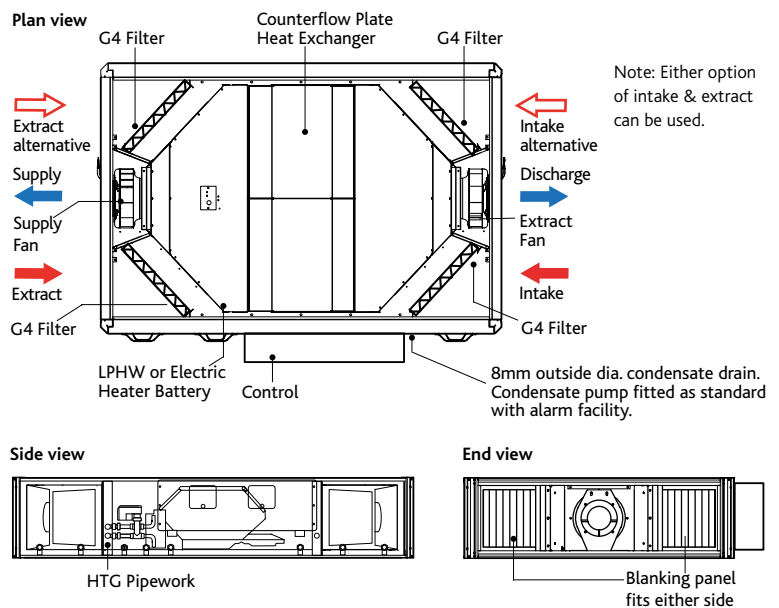

| Fan Unit Dimensions (mm) | | | Control for all Models Dimensions (mm) | | | Rectangular Aperture Dimensions (mm) | | | Weather Roof for Code XBC10-H-WP | | | Service & Maintenance Requirements | | |
|--------------------------|------|-----|--|-----|-----|--------------------------------------|-----|-----|----------------------------------|------|------|--|---|--|
| A | B | C | E | F | G | J | K | M | H | x | W | x | L | |
| 1900 | 1560 | 470 | 120 | 200 | 670 | 398 | 430 | 588 | 95 | 1560 | 2200 | The unit is designed for side access as standard and must be installed with a minimum of 260mm clearance from a wall or barrier. This will provide access to filters, coil, fan, heat exchanger, condensate tray and pump. | | |

2 attenuator flanges are attached to every unit. Add 50mm to dimension 'A' to include both flanges. Weather roof is separate code and can be retro fitted on site.

XBC55 HORIZONTAL HEAT EXCHANGE UNITS

PERFORMANCE & TECHNICAL INFORMATION

XBC55 FAN - SOUND DATA

| Fan Speed | Sound Power Levels (dB re 1 pW) | Frequency (Hz) | | | | | | | | Spherical dBA@3m | Fan Speed | External Static Pressure (Pa) | | | | | | | | Spherical dBA@3m |
|-----------|---------------------------------|----------------|-----|-----|-----|------|------|------|------|------------------|-----------|-------------------------------|-----|-----|------|------|------|------|------|------------------|
| | | 63 | 125 | 250 | 500 | 1000 | 2000 | 4000 | 8000 | | | 63 | 125 | 250 | 500 | 1000 | 2000 | 4000 | 8000 | |
| 100% | Induct Intake | 81 | 74 | 75 | 63 | 64 | 61 | 53 | 41 | 35 | 50% | 66 | 59 | 60 | 48 | 49 | 46 | 38 | 26 | 20 |
| | Induct Supply | 85 | 80 | 84 | 71 | 72 | 70 | 66 | 61 | | | 70 | 65 | 69 | 56 | 57 | 55 | 51 | 46 | |
| | Induct Discharge | 86 | 81 | 84 | 71 | 72 | 71 | 66 | 63 | | | 71 | 66 | 69 | 56 | 57 | 56 | 51 | 48 | |
| | Induct Extract | 82 | 75 | 75 | 63 | 64 | 62 | 53 | 43 | | | 67 | 60 | 60 | 48 | 49 | 47 | 38 | 28 | |
| | Casing Radiated | 72 | 65 | 61 | 47 | 45 | 43 | 40 | 28 | | | 57 | 50 | 46 | 32 | 30 | 28 | 25 | 13 | |
| 75% | Induct Intake | 75 | 68 | 69 | 57 | 58 | 55 | 47 | 35 | 28 | 25% | 51 | 44 | 45 | 33 | 34 | 31 | 23 | < 20 | < 20 |
| | Induct Supply | 79 | 74 | 78 | 65 | 66 | 64 | 60 | 55 | | | 55 | 50 | 54 | 41 | 42 | 40 | 36 | 31 | |
| | Induct Discharge | 80 | 75 | 78 | 65 | 66 | 65 | 60 | 57 | | | 56 | 51 | 54 | 41 | 42 | 41 | 36 | 33 | |
| | Induct Extract | 76 | 69 | 69 | 57 | 58 | 56 | 47 | 37 | | | 52 | 45 | 45 | 33 | 34 | 32 | 23 | < 20 | |
| | Casing Radiated | 66 | 59 | 55 | 41 | 39 | 37 | 34 | 22 | | | 42 | 35 | 31 | < 20 | < 20 | < 20 | < 20 | < 20 | |

*Casing Radiated (Breakout).

ATTENUATOR DIMENSIONS (mm), DYNAMIC INSERTION LOSS (dB) & WEIGHTS (kg)

| Attenuator Code | Attenuator Dimensions | | | Air path | Dynamic Insertion Loss (dB) | | | | | | | | Attenuator Weight (kg) | Packed Weight (kg) |
|-----------------|-----------------------|-------|--------|----------|-----------------------------|-----|-----|-----|------|------|------|------|------------------------|--------------------|
| | Length | Width | Height | | 63 | 125 | 250 | 500 | 1000 | 2000 | 4000 | 8000 | | |
| XBC55-HS-MS10 | 1050 | 592 | 428 | S / D | 4 | 10 | 17 | 19 | 23 | 18 | 15 | 11 | 54 | 59 |
| XBC55-HE-MS10 | 1050 | 402 | 428 | I / E | 3 | 6 | 12 | 15 | 15 | 11 | 6 | 4 | 47 | 50 |
| XBC55-HS-MS12 | 1250 | 592 | 428 | S / D | 6 | 12 | 21 | 26 | 31 | 24 | 18 | 13 | 67 | 72 |
| XBC55-HE-MS12 | 1250 | 402 | 428 | I / E | 5 | 8 | 16 | 22 | 23 | 17 | 9 | 6 | 57 | 60 |
| XBC55-HS-MS16 | 1600 | 592 | 428 | S / D | 8 | 14 | 25 | 33 | 37 | 30 | 21 | 15 | 84 | 89 |
| XBC55-HE-MS16 | 1600 | 402 | 428 | I / E | 7 | 10 | 20 | 29 | 29 | 23 | 12 | 8 | 71 | 74 |

S / D = Supply / Discharge I / E = Intake / Extract. Coding: The S / D denotes the type of silencer required for the supply or discharge. The I / E denotes the type of silencer required for the extract or fresh air intake on the unit. All XBC matched silencers are double skinned.

COUNTERFLOW HEAT EXCHANGER EFFICIENCY (%)

Performance based on:
Indoor Conditions 21 Deg C / 50 % RH

Key to performance curves

- Intake Temperature (Deg C)
- 5 Deg C Intake Typically Specified Values
- 3 Deg C Intake Typically Specified Values
- 1 Deg C Intake Typically Specified Values
- 6 Deg C Approx. Average outdoor temperature (UK heating season)

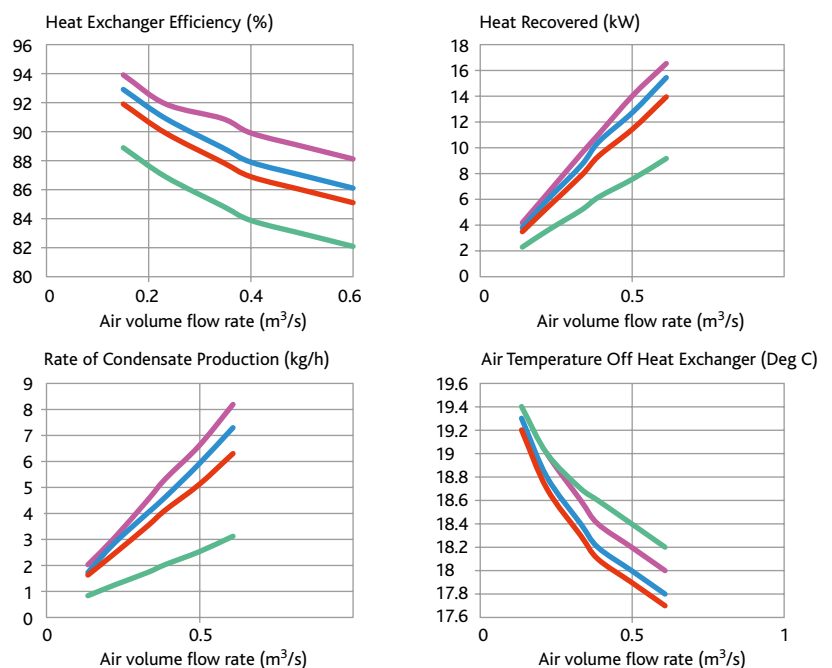

HEATING COIL DATA LPHW

| LPHW Deg C | Airflow (m³/s) | Output (kW) | Air Off Temp (C*) | Water flow (l/s) | Coil ΔP (kPa) | Pipe Connection (mm) | Valve ΔP (kPa) | Valve Type |
|------------|----------------|-------------|-------------------|------------------|---------------|----------------------|----------------|------------|
| LPHW 82/71 | 0.5 | 12.0 | 30 | 0.27 | 8.6 | 15 | 9 | 4 Port |
| | 0.375 | 11.3 | 35 | 0.25 | 7.6 | 15 | 8.0 | |
| | 0.25 | 8.9 | 40 | 0.20 | 4.7 | 15 | 4.9 | |
| LPHW 80/60 | 0.5 | 9.7 | 26 | 0.12 | 1.7 | 15 | 1.7 | 4 Port |
| | 0.375 | 8.7 | 29 | 0.11 | 1.5 | 15 | 1.5 | |
| | 0.25 | 6.9 | 33 | 0.09 | 0.9 | 15 | 0.9 | |
| LPHW 60/40 | 0.5 | 5.6 | 19 | 0.07 | 0.6 | 15 | 0.6 | 4 Port |
| | 0.375 | 5.2 | 21 | 0.06 | 0.5 | 15 | 0.5 | |
| | 0.25 | 4.0 | 23 | 0.05 | 0.3 | 15 | 0.3 | |

*Nb Limited to 30 Deg C for Ecosmart Units. Data based on 10 Deg C Air On temperature.

XBC65 HORIZONTAL HEAT EXCHANGE UNITS

PERFORMANCE & TECHNICAL INFORMATION

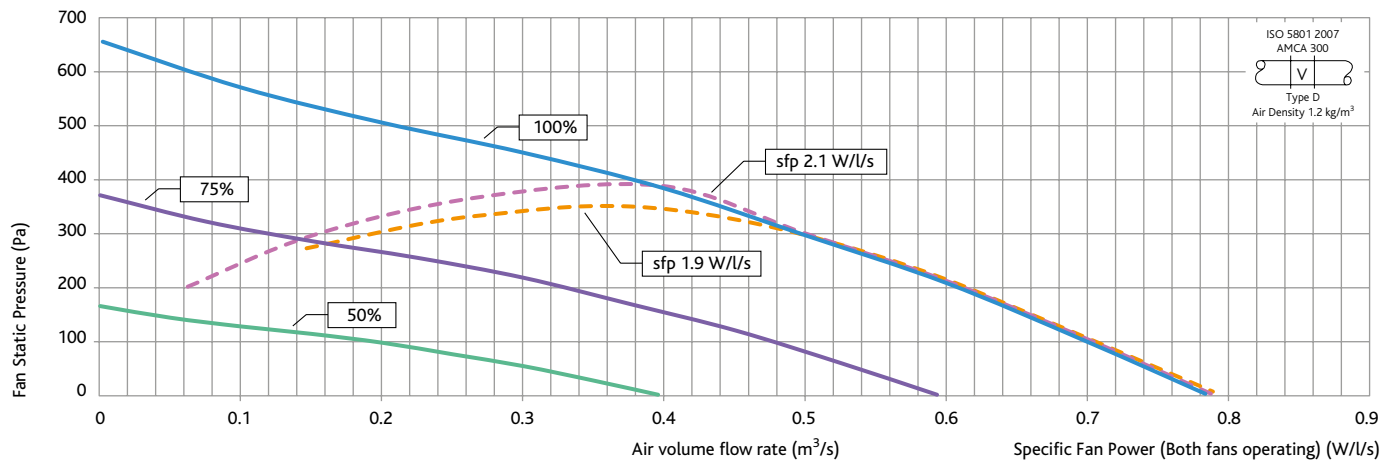

XBC65 UNIT PERFORMANCE - EXAMPLE 0.55m³/s @ 150Pa = SFP 1.2, 32dBA @ 3m

| Fan Speed | | External Static Pressure (Pa) | | | | | | | | Fan Speed | | External Static Pressure (Pa) | | | | | | | |
|-----------|-----------------------------|-------------------------------|--------|------|--------|------|------|-----------------------------|------|-----------|-----------------------------|-------------------------------|------|------|-----|-----------------------------|------|-----|-----|
| | | 0 | 50 | 100 | 200 | 300 | 400 | 500 | 600 | | | 700 | 0 | 50 | 100 | 200 | 300 | 400 | 500 |
| 100% | Airflow (m ³ /s) | 0.78 | 0.75 | 0.71 | 0.62 | 0.50 | 0.37 | 0.22 | 0.08 | 50% | Airflow (m ³ /s) | 0.39 | 0.31 | 0.18 | 25% | Airflow (m ³ /s) | 0.20 | | |
| | sfp (W/l/s) | 1.20 | 1.28 | 1.34 | 1.52 | 1.78 | 2.20 | 3.40 | 3.95 | | sfp (W/l/s) | 0.30 | 0.38 | 0.55 | | sfp (W/l/s) | 0.10 | | |
| | dBA@3m | 35 | dBA@3m | 20 | dBA@3m | < 20 | | | | | | | | | | | | | |
| 75% | Airflow (m ³ /s) | 0.59 | 0.54 | 0.48 | 0.32 | 0.13 | 25% | Airflow (m ³ /s) | 0.20 | | | | | | | | | | |
| | sfp (W/l/s) | 0.68 | 0.75 | 0.83 | 1.10 | 2.50 | | sfp (W/l/s) | 0.10 | | | | | | | | | | |
| | dBA@3m | 29 | dBA@3m | < 20 | | | | | | | | | | | | | | | |

Specific Fan Power figures are the total for both fans operating.

For accurate figures, please refer to Nuair Fan Selection Programme at www.nuair.co.uk

| Unit Code | Voltage / Phase / Frequency | Input Power (W) | FLC / SC (A) | Max Operating Temperature | Fan Speed (rpm) | Unit Weight (kg) | Packed Weight (kg) | Pallet / crate dimensions (mm) | | |
|-------------|-----------------------------|-----------------|--------------|---------------------------|-----------------|------------------|--------------------|--------------------------------|----------------------|----------------------|
| | | | | | | | | 2150L x 1800W x 800H | 2150L x 1800W x 800H | 2150L x 1800W x 800H |
| XBC65-H-L** | 230 / 1 / 50 | 1540 | 8 / 8 | 40°C | 1700 | 469 | 619 | 2150L x 1800W x 800H | | |
| XBC65-H-E** | 230 / 1 / 50 | 10540* | 47 / 47 | 40°C | 1700 | 476 | 626 | 2150L x 1800W x 800H | | |
| XBC65-H-N** | 230 / 1 / 50 | 1540 | 8 / 8 | 40°C | 1700 | 465 | 615 | 2150L x 1800W x 800H | | |

**Add relevant code ie: BC, ES, CO or AT for control type. *Includes 9kW Electric Heater.

FAN UNIT DIMENSIONS (mm)

Note: All models (BC, ES, CO or AT) have a fold down (90°) pivoting control box for easy commissioning.

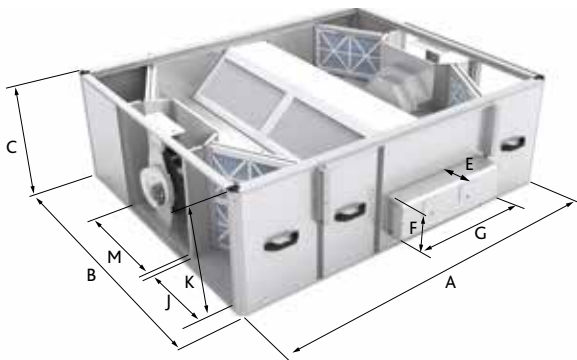

XBC65 FAN CONFIGURATION

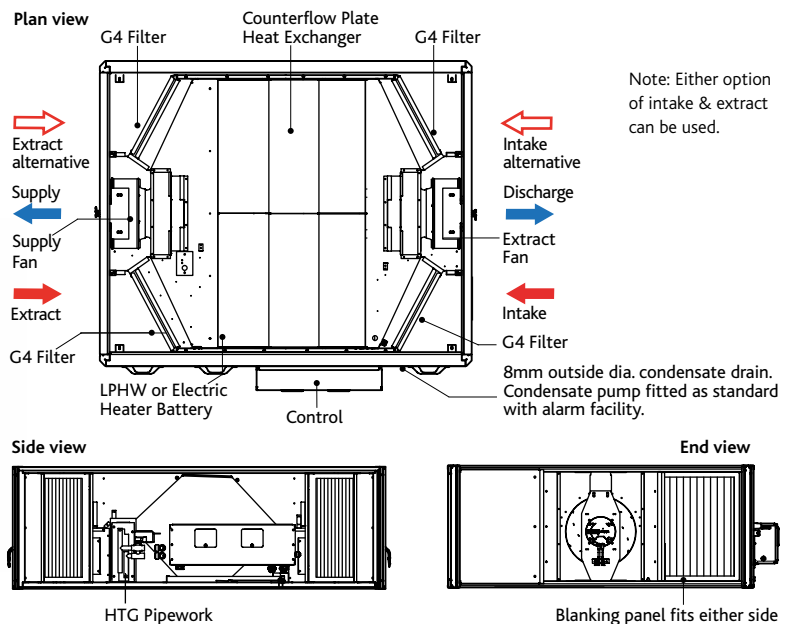

| Fan Unit Dimensions (mm) | | | Control for all Models Dimensions (mm) | | | Rectangular Aperture Dimensions (mm) | | | Weather Roof for Code XBC10-H-WP | | | Service & Maintenance Requirements | |
|--------------------------|------|-----|--|-----|-----|--------------------------------------|-----|-----|----------------------------------|------|------|--|---|
| A | B | C | E | F | G | J | K | M | H | x | W | | x |
| 1900 | 1560 | 620 | 120 | 200 | 670 | 398 | 580 | 588 | 95 | 1560 | 2200 | The unit is designed for side access as standard and must be installed with a minimum of 260mm clearance from a wall or barrier. This will provide access to filters, coil, fan, heat exchanger, condensate tray and pump. | |

2 attenuator flanges are attached to every unit. Add 50mm to dimension 'A' to include both flanges. Weather roof is separate code and can be retro fitted on site.

XBC65 HORIZONTAL HEAT EXCHANGE UNITS

PERFORMANCE & TECHNICAL INFORMATION

XBC65 FAN - SOUND DATA

| Fan Speed | Sound Power Levels (dB re 1 pW) | Frequency (Hz) | | | | | | | | Spherical dBA@3m | Fan Speed | External Static Pressure (Pa) | | | | | | | | Spherical dBA@3m |
|-----------|---------------------------------|----------------|-----|-----|-----|------|------|------|------|------------------|-----------|-------------------------------|-----|-----|-----|------|------|------|------|------------------|
| | | 63 | 125 | 250 | 500 | 1000 | 2000 | 4000 | 8000 | | | 63 | 125 | 250 | 500 | 1000 | 2000 | 4000 | 8000 | |
| 100% | Induct Intake | 79 | 79 | 72 | 66 | 64 | 59 | 48 | 34 | 35 | 50% | 64 | 64 | 57 | 51 | 49 | 44 | 33 | < 20 | 20 |
| | Induct Supply | 83 | 85 | 79 | 74 | 72 | 68 | 61 | 54 | | | 68 | 70 | 64 | 59 | 57 | 53 | 46 | 39 | |
| | Induct Discharge | 85 | 85 | 79 | 75 | 72 | 69 | 61 | 55 | | | 70 | 70 | 64 | 60 | 57 | 54 | 46 | 40 | |
| | Induct Extract | 81 | 79 | 70 | 67 | 64 | 60 | 48 | 35 | | | 66 | 64 | 55 | 52 | 49 | 45 | 33 | 20 | |
| | Casing Radiated | 71 | 69 | 56 | 51 | 45 | 41 | 35 | 20 | | | 56 | 54 | 41 | 36 | 30 | 26 | 20 | < 20 | |
| 75% | Induct Intake | 73 | 73 | 66 | 60 | 58 | 53 | 42 | 28 | 29 | 25% | 49 | 49 | 42 | 36 | 34 | 29 | < 20 | < 20 | < 20 |
| | Induct Supply | 77 | 79 | 73 | 68 | 66 | 62 | 55 | 48 | | | 53 | 55 | 49 | 44 | 42 | 38 | 31 | 24 | |
| | Induct Discharge | 79 | 79 | 73 | 69 | 66 | 63 | 55 | 49 | | | 55 | 55 | 49 | 45 | 42 | 39 | 31 | 25 | |
| | Induct Extract | 75 | 73 | 64 | 61 | 58 | 54 | 42 | 29 | | | 51 | 49 | 40 | 37 | 34 | 30 | 18 | 5 | |
| | Casing Radiated | 65 | 63 | 50 | 45 | 39 | 35 | 29 | < 20 | | | 41 | 39 | 26 | 21 | < 20 | < 20 | < 20 | < 20 | |

*Casing Radiated (Breakout).

ATTENUATOR DIMENSIONS (mm), DYNAMIC INSERTION LOSS (dB) & WEIGHTS (kg)

| Attenuator Code | Attenuator Dimensions | | | Air path | Dynamic Insertion Loss (dB) | | | | | | | | Attenuator Weight (kg) | Packed Weight (kg) |
|-----------------|-----------------------|-------|--------|----------|-----------------------------|-----|-----|-----|------|------|------|------|------------------------|--------------------|
| | Length | Width | Height | | 63 | 125 | 250 | 500 | 1000 | 2000 | 4000 | 8000 | | |
| XBC65-HS-MS10 | 1050 | 592 | 578 | S / D | 4 | 11 | 14 | 23 | 23 | 22 | 14 | 9 | 63 | 68 |
| XBC65-HE-MS10 | 1050 | 402 | 578 | I / E | 3 | 8 | 12 | 15 | 10 | 6 | 3 | 2 | 55 | 58 |
| XBC65-HS-MS12 | 1250 | 592 | 578 | S / D | 6 | 13 | 18 | 30 | 31 | 28 | 17 | 11 | 77 | 82 |
| XBC65-HE-MS12 | 1250 | 402 | 578 | I / E | 5 | 10 | 16 | 22 | 18 | 12 | 6 | 4 | 67 | 70 |
| XBC65-HS-MS16 | 1600 | 592 | 578 | S / D | 8 | 15 | 22 | 37 | 37 | 34 | 20 | 13 | 96 | 101 |
| XBC65-HE-MS16 | 1600 | 402 | 578 | I / E | 7 | 12 | 20 | 29 | 24 | 18 | 9 | 6 | 84 | 87 |

S / D = Supply / Discharge I / E = Intake / Extract. Coding: The S / D denotes the type of silencer required for the supply or discharge. The I / E denotes the type of silencer required for the extract or fresh air intake on the unit. All XBC matched silencers are double skinned.

COUNTERFLOW HEAT EXCHANGER EFFICIENCY (%)

Performance based on:
Indoor Conditions 21 Deg C / 50 % RH

Key to performance curves

- Intake Temperature (Deg C)
- 5 Deg C Intake Typically Specified Values
- 3 Deg C Intake Typically Specified Values
- 1 Deg C Intake Typically Specified Values
- 6 Deg C Approx. Average outdoor temperature (UK heating season)

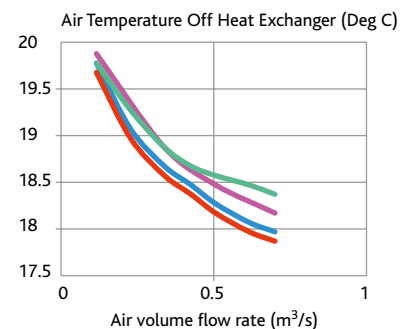
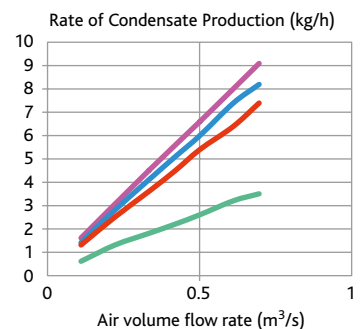
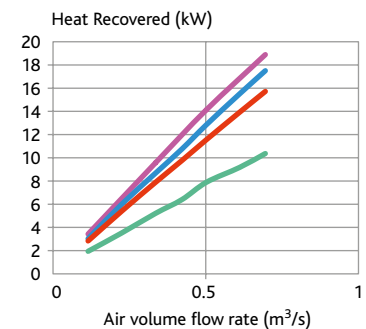
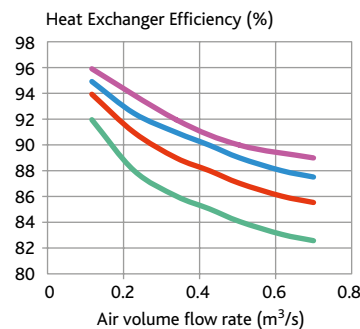

HEATING COIL DATA LPHW

| LPHW Deg C | Airflow (m³/s) | Output (kW) | Air Off Temp (C*) | Water flow (l/s) | Coil ΔP (kPa) | Pipe Connection (mm) | Valve ΔP (kPa) | Valve Type |
|------------|----------------|-------------|-------------------|------------------|---------------|----------------------|----------------|------------|
| LPHW 82/71 | 0.6 | 14.4 | 30 | 0.32 | 15.0 | 22 | 15 | 4 Port |
| | 0.45 | 13.5 | 35 | 0.30 | 13.3 | 22 | 13.3 | |
| | 0.3 | 10.7 | 40 | 0.24 | 8.2 | 22 | 8.2 | |
| LPHW 80/60 | 0.6 | 11.6 | 26 | 0.15 | 3.0 | 22 | 3 | 4 Port |
| | 0.45 | 10.4 | 29 | 0.13 | 2.7 | 22 | 2.7 | |
| | 0.3 | 8.2 | 33 | 0.10 | 1.6 | 22 | 1.6 | |
| LPHW 60/40 | 0.6 | 6.7 | 19 | 0.08 | 1.0 | 22 | 1 | 4 Port |
| | 0.45 | 6.2 | 21 | 0.07 | 0.8 | 22 | 0.8 | |
| | 0.3 | 4.8 | 23 | 0.06 | 0.5 | 22 | 0.5 | |

*Nb Limited to 30 Deg C for Ecosmart Units. Data based on 10 Deg C Air On temperature.

XBOXER XBC10-65 HORIZONTAL UNITS

ANCILLARIES

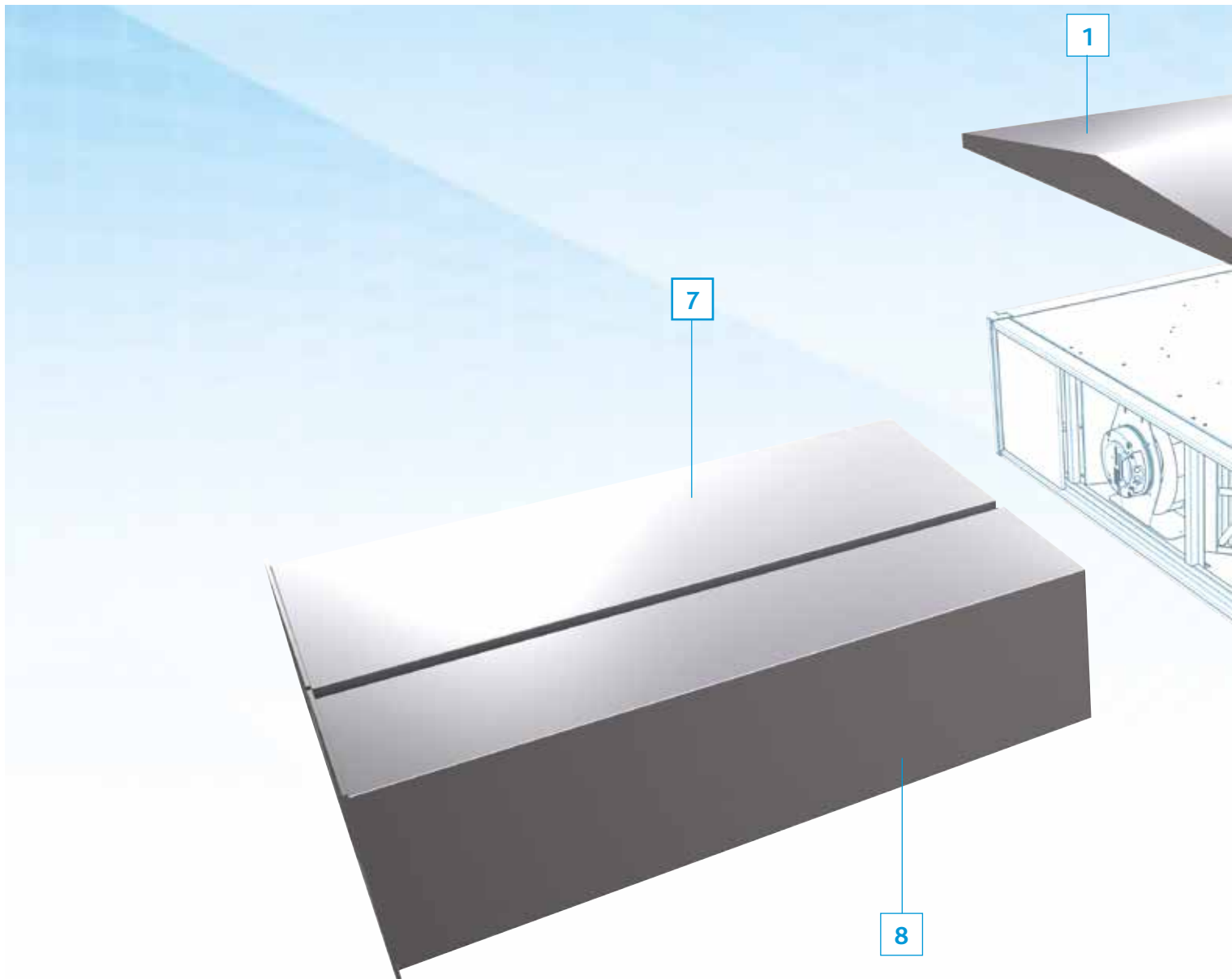

QUICK SELECTION GUIDE XBC10 - 65 HORIZONTAL UNITS - ANCILLARIES

| XBC Unit Size | Format | 1 | 2 | 3 | 4 | | |
|---------------|------------|--------------------------|-----------------------|----------------------|-------------------------------|----------|----------|
| | | Weather Kit (All models) | Exhaust Roof Terminal | Intake Roof Terminal | Replacement Filter Options G3 | G4 | F7 |
| XBC10 | Horizontal | XBC15-H-WP | XBC15-EXHAUST-RT | XBC15-INTAKE-RT | XBC10-G3 | n/a | n/a |
| XBC15 | Horizontal | XBC15-H-WP | XBC15-EXHAUST-RT | XBC15-INTAKE-RT | n/a | XBC15-G4 | XBC15-F7 |
| XBC25 | Horizontal | XBC25-H-WP | XBC25-EXHAUST-RT | XBC25-INTAKE-RT | n/a | XBC25-G4 | XBC25-F7 |
| XBC45 | Horizontal | XBC45-H-WP | XBC45-EXHAUST-RT | XBC45-INTAKE-RT | n/a | XBC45-G4 | XBC45-F7 |
| XBC55 | Horizontal | XBC55-H-WP | XBC55-EXHAUST-RT | XBC55-INTAKE-RT | n/a | XBC55-G4 | XBC55-F7 |
| XBC65 | Horizontal | XBC65-H-WP | XBC65-EXHAUST-RT | XBC65-INTAKE-RT | n/a | XBC65-G4 | XBC65-F7 |

| XBC Unit Size | Format | 5 | | 6 | |
|---------------|------------|--------------------------------|-------------|--------------------------------|----------------|
| | | Motorised Dampers (internal)** | | Motorised Dampers (external)** | |
| | | ES & BC models | AT models | ES & BC models | AT models |
| XBC10 | Horizontal | XBC10-MD | XBC10-MD-AT | XBC10-MD-WP | XBC10-MD-AT-WP |
| XBC15 | Horizontal | XBC15-MD | XBC15-MD-AT | XBC15-MD-WP | XBC15-MD-AT-WP |
| XBC25 | Horizontal | XBC25-MD | XBC25-MD-AT | XBC25-MD-WP | XBC25-MD-AT-WP |
| XBC45 | Horizontal | XBC45-MD | XBC45-MD-AT | XBC45-MD-WP | XBC45-MD-AT-WP |
| XBC55 | Horizontal | XBC55-MD | XBC55-MD-AT | XBC55-MD-WP | XBC55-MD-AT-WP |
| XBC65 | Horizontal | XBC65-MD | XBC65-MD-AT | XBC65-MD-WP | XBC65-MD-AT-WP |

XBOXER XBC10-65 HORIZONTAL UNITS ANCILLARIES

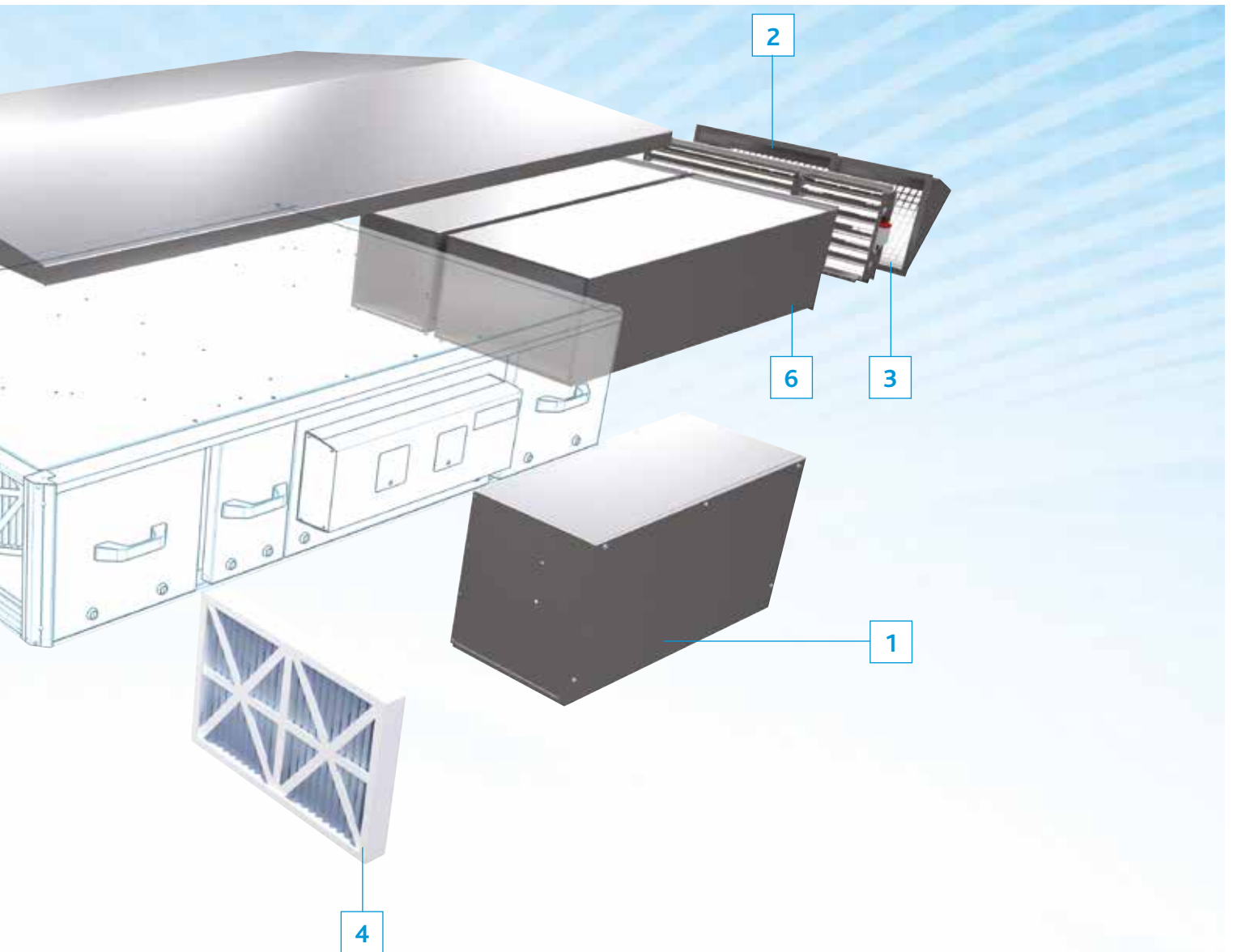

Refer to page 30-31 for bend silencer details. For details on Constant Pressure refer to pages 50-53.

QUICK SELECTION GUIDE XBC10 - 65 HORIZONTAL UNITS - MATCHING STRAIGHT ATTENUATORS

| XBC Unit Size | Format | 7 | | | 8 | | |
|---------------|------------|---------------------------------|---------------|---------------|----------------------------------|---------------|---------------|
| | | Matching Silencers S/D (Supply) | | | Matching Silencers I/E (Extract) | | |
| | | 1050mm long | 1250mm long | 1600mm long | 1050mm long | 1250mm long | 1600mm long |
| XBC10 | Horizontal | XBC15-HS-MS10 | XBC15-HS-MS12 | XBC15-HS-MS16 | XBC15-HE-MS10 | XBC15-HE-MS12 | XBC15-HE-MS16 |
| XBC15 | Horizontal | XBC15-HS-MS10 | XBC15-HS-MS12 | XBC15-HS-MS16 | XBC15-HE-MS10 | XBC15-HE-MS12 | XBC15-HE-MS16 |
| XBC25 | Horizontal | XBC25-HS-MS10 | XBC25-HS-MS12 | XBC25-HS-MS16 | XBC25-HE-MS10 | XBC25-HE-MS12 | XBC25-HE-MS16 |
| XBC45 | Horizontal | XBC45-HS-MS10 | XBC45-HS-MS12 | XBC45-HS-MS16 | XBC45-HE-MS10 | XBC45-HE-MS12 | XBC45-HE-MS16 |
| XBC55 | Horizontal | XBC55-HS-MS10 | XBC55-HS-MS12 | XBC55-HS-MS16 | XBC55-HE-MS10 | XBC55-HE-MS12 | XBC55-HE-MS16 |
| XBC65 | Horizontal | XBC65-HS-MS10 | XBC65-HS-MS12 | XBC65-HS-MS16 | XBC65-HE-MS10 | XBC65-HE-MS12 | XBC65-HE-MS16 |

Matching flange is supplied attached to all XBC units.

ACOUSTIC STRAIGHT ATTENUATOR COMBINATION EXAMPLES

Matched silencers can be flipped to suit left/right side. (1050/1250/1600mm lengths).
*Contact Nuairé for details of these variants.



XBOXER XBC10-65 HORIZONTAL UNITS

ANCILLARIES - NEW BEND SILENCERS



WHERE TO USE BEND ATTENUATORS

The New bend matched silencers are ideal for projects where space is limited and the straight matched silencers cannot be fitted.

The bend silencers are fitted with the matching flange at either end allow for additional straight silencers to also be added if required.

Supply/Discharge Bend Attenuator

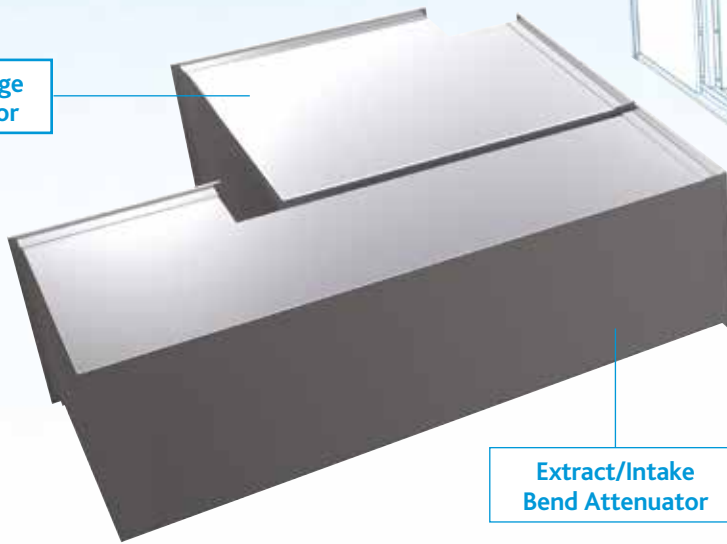

Extract/Intake Bend Attenuator

ACOUSTIC BEND ATTENUATOR COMBINATION EXAMPLES

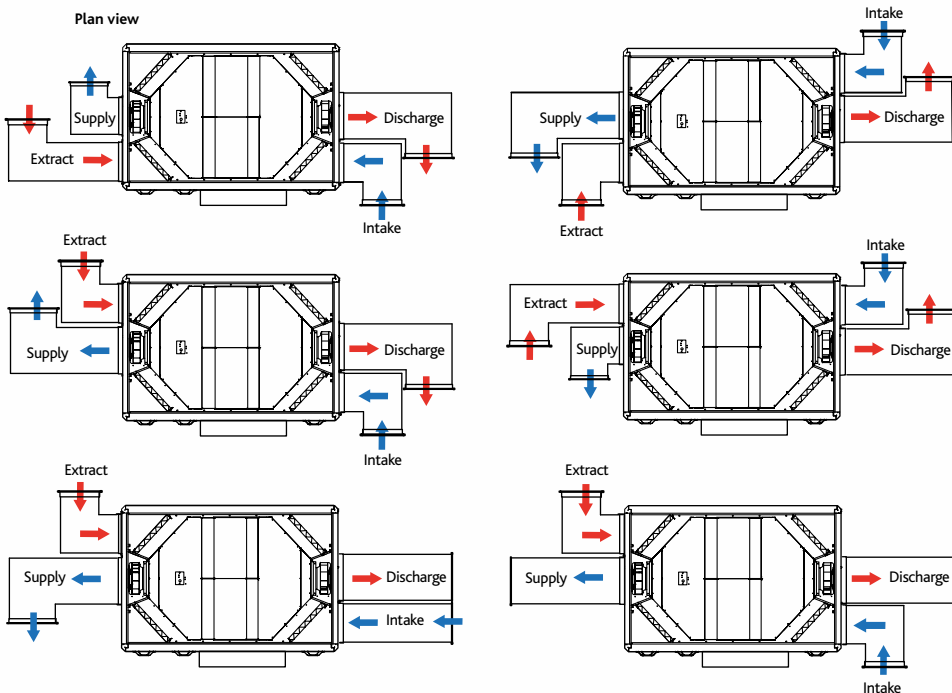

BEND SILENCER CODE DESCRIPTION

XBC15-HE-MBS-S

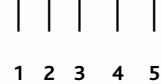

1. XBOXER XBC Range
2. Unit size: 15, 25, 45, 55 or 65
3. HE = Horizontal Extract/Intake
HS = Horizontal Supply/Discharge
4. Matched Bend Silencer
5. S = Short (refer to dimensions)
L = Long (refer to dimensions)

XBOXER XBC10-65 HORIZONTAL UNITS

ANCILLARIES - NEW BEND SILENCERS

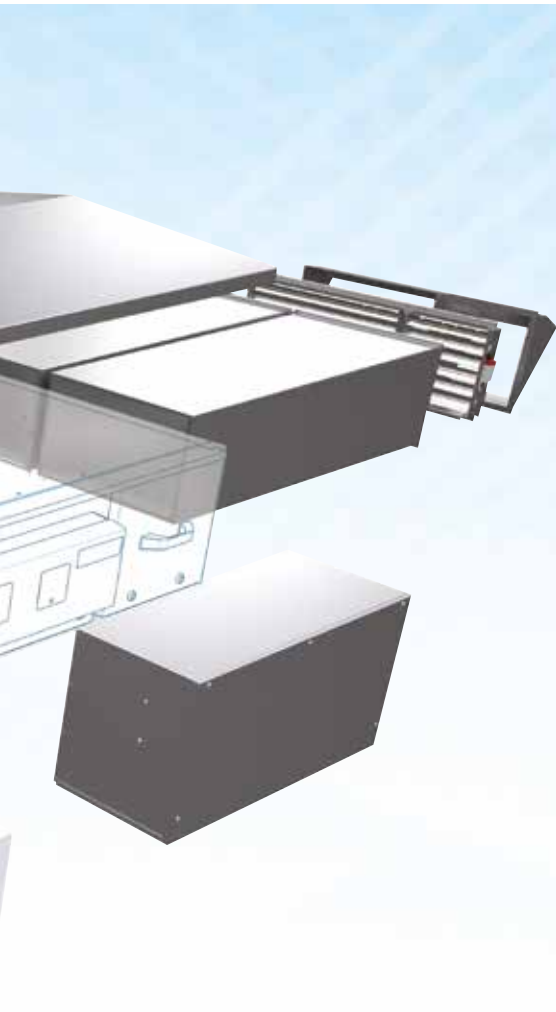

XBC10 - 65 HORIZONTAL UNITS BEND ATTENUATOR DIMENSIONS

Side view



Plan view

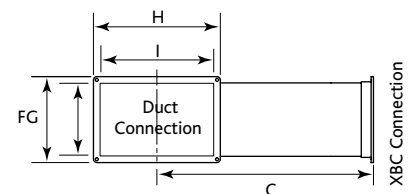
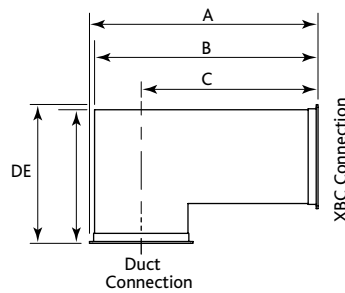
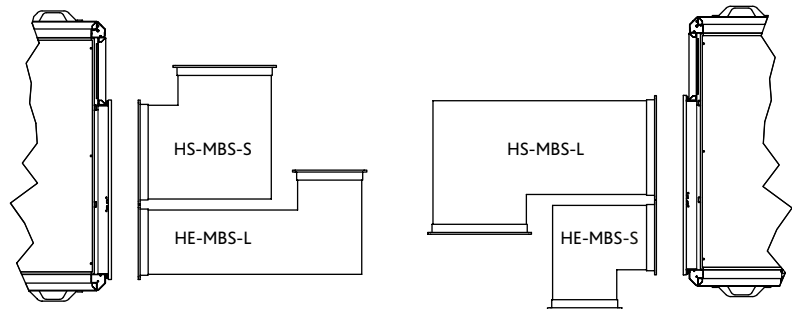

XBC10 - 65 HORIZONTAL UNITS BEND ATTENUATOR DIMENSIONS (mm), DYNAMIC INSERTION LOSS (dB) & WEIGHTS (kg)

| XBC Unit size | Attenuator Code | Attenuator Dimensions | | | | | | | | | Dynamic Insertion Loss (dB) | | | | | | | | Attenuator Weight (kg) | "Z" Factor |
|---------------|-----------------|-----------------------|------|------|-----|-----|-----|-----|-----|-----|-----------------------------|-----|-----|-----|------|------|------|------|------------------------|------------|
| | | A | B | C | D | E | F | G | H | I | 63 | 125 | 250 | 500 | 1000 | 2000 | 4000 | 8000 | | |
| XBC10 | XBC15-HS-MBS-S | 515 | 496 | 322 | 515 | 496 | 260 | 220 | 386 | 346 | 2 | 4 | 9 | 17 | 30 | 33 | 25 | 19 | 36 | 900.0 |
| XBC10 | XBC15-HS-MBS-L | 852 | 833 | 659 | 515 | 496 | 260 | 220 | 386 | 346 | 2 | 5 | 12 | 22 | 38 | 39 | 28 | 22 | 46 | 1100.0 |
| XBC10 | XBC15-HE-MBS-S | 406 | 387 | 268 | 406 | 387 | 260 | 220 | 277 | 237 | 2 | 4 | 10 | 18 | 32 | 35 | 25 | 20 | 36 | 2000.0 |
| XBC10 | XBC15-HE-MBS-L | 852 | 833 | 714 | 406 | 387 | 260 | 220 | 277 | 237 | 3 | 5 | 13 | 24 | 42 | 41 | 29 | 23 | 44 | 2300.0 |
| XBC15 | XBC15-HS-MBS-S | 515 | 496 | 322 | 515 | 496 | 260 | 220 | 386 | 346 | 2 | 4 | 9 | 17 | 30 | 33 | 25 | 19 | 36 | 2300.0 |
| XBC15 | XBC15-HS-MBS-L | 852 | 833 | 659 | 515 | 496 | 260 | 220 | 386 | 346 | 2 | 5 | 12 | 22 | 38 | 39 | 28 | 22 | 46 | 2300.0 |
| XBC15 | XBC15-HE-MBS-S | 406 | 387 | 268 | 406 | 387 | 260 | 220 | 277 | 237 | 2 | 4 | 10 | 18 | 32 | 35 | 25 | 20 | 36 | 2300.0 |
| XBC15 | XBC15-HE-MBS-L | 852 | 833 | 714 | 406 | 387 | 260 | 220 | 277 | 237 | 3 | 5 | 13 | 24 | 42 | 41 | 29 | 23 | 44 | 2300.0 |
| XBC25 | XBC25-HS-MBS-S | 640 | 621 | 385 | 640 | 621 | 342 | 302 | 511 | 471 | 2 | 4 | 8 | 16 | 29 | 22 | 14 | 10 | 50 | 156.3 |
| XBC25 | XBC25-HS-MBS-L | 992 | 973 | 737 | 640 | 621 | 342 | 302 | 511 | 471 | 2 | 5 | 10 | 21 | 38 | 25 | 17 | 13 | 64 | 173.6 |
| XBC25 | XBC25-HE-MBS-S | 421 | 402 | 275 | 421 | 402 | 342 | 302 | 292 | 252 | 2 | 4 | 8 | 16 | 29 | 22 | 14 | 10 | 40 | 208.3 |
| XBC25 | XBC25-HE-MBS-L | 992 | 973 | 846 | 421 | 402 | 342 | 302 | 292 | 252 | 2 | 5 | 10 | 38 | 25 | 17 | 13 | 50 | 54 | 225.7 |
| XBC45 | XBC45-HS-MBS-S | 700 | 681 | 415 | 700 | 681 | 400 | 360 | 571 | 531 | 3 | 6 | 9 | 17 | 29 | 21 | 13 | 7 | 60 | 116.9 |
| XBC45 | XBC45-HS-MBS-L | 1070 | 1051 | 785 | 700 | 681 | 400 | 360 | 571 | 531 | 4 | 7 | 10 | 21 | 37 | 26 | 15 | 8 | 76 | 131.5 |
| XBC45 | XBC45-HE-MBS-S | 439 | 420 | 284 | 439 | 420 | 400 | 360 | 310 | 270 | 3 | 6 | 9 | 17 | 29 | 21 | 13 | 7 | 42 | 146.1 |
| XBC45 | XBC45-HE-MBS-L | 1070 | 1051 | 915 | 439 | 420 | 400 | 360 | 310 | 270 | 4 | 7 | 10 | 21 | 37 | 26 | 15 | 8 | 58 | 160.7 |
| XBC55 | XBC55-HS-MBS-S | 756 | 737 | 443 | 756 | 737 | 470 | 430 | 627 | 587 | 3 | 7 | 10 | 21 | 37 | 26 | 15 | 8 | 68 | 80.0 |
| XBC55 | XBC55-HS-MBS-L | 1253 | 1234 | 940 | 756 | 737 | 470 | 430 | 627 | 587 | 4 | 10 | 18 | 31 | 39 | 24 | 12 | 7 | 96 | 92.0 |
| XBC55 | XBC55-HE-MBS-S | 566 | 547 | 348 | 566 | 547 | 470 | 430 | 437 | 397 | 3 | 6 | 10 | 18 | 24 | 16 | 9 | 6 | 48 | 80.0 |
| XBC55 | XBC55-HE-MBS-L | 1253 | 1234 | 1035 | 566 | 547 | 470 | 430 | 437 | 397 | 4 | 10 | 18 | 31 | 39 | 24 | 12 | 7 | 72 | 100.0 |
| XBC65 | XBC65-HS-MBS-S | 756 | 737 | 443 | 756 | 737 | 620 | 580 | 627 | 587 | 3 | 8 | 14 | 23 | 22 | 14 | 7 | 4 | 76 | 44.4 |
| XBC65 | XBC65-HS-MBS-L | 1253 | 1234 | 940 | 756 | 737 | 620 | 580 | 627 | 587 | 14 | 10 | 19 | 31 | 30 | 18 | 9 | 5 | 106 | 50.0 |
| XBC65 | XBC65-HE-MBS-S | 566 | 547 | 348 | 566 | 547 | 620 | 580 | 437 | 397 | 3 | 8 | 14 | 23 | 22 | 14 | 7 | 4 | 54 | 55.6 |
| XBC65 | XBC65-HE-MBS-L | 1253 | 1234 | 1035 | 566 | 547 | 620 | 580 | 437 | 397 | 4 | 10 | 19 | 31 | 30 | 18 | 9 | 5 | 86 | 63.9 |

Matching flange is supplied attached to all XBC units. Note: Air Pressure Drop of Attenuator (Pa) = Z*Q² where Z = Factor listed in table above Pa/Q².

Coding: HS - denotes the type of silencer required for the supply or discharge. HE - denotes the type of silencer required for the extract or intake.

Note: XBC15 silencers are also suitable for XBC10 units.

XBC10-65 HORIZONTAL HEAT EXCHANGE UNITS

CONSULTANTS SPECIFICATION

OPERATION

The supply and extract ventilation unit shall be configured as indicated on the drawings. The heat recovery ventilation unit shall enable the room design conditions to be maintained by the effective and continuous control of ventilation rate, the integrated counterflow heat exchanger matrix and bypass, and heating facility.

The ventilation unit shall automatically vary the ventilation rate in the space dependent upon the signals received from the interconnected sensors and user interface (where provided). When signals are received, the unit shall vary its fan speeds proportionally until the desired set points are met.

The unit shall have the facility to commission the supply and extract fans individually via inbuilt maximum, minimum and offset speed adjustments. Each fan shall have stepless variable speed control (20 – 100% of maximum). The unit shall be the XBC10-65** as manufactured by Nuair.

UNIT SPECIFICATION

The heat recovery ventilation unit together with matching silencers shall have a maximum depth of 260 / 340 / 400 / 470 / 620mm (Models XBC10 to 65**).

The ventilation unit and attenuators shall have an asymmetric, high mass double skinned wall construction (patent applied for) with integral acoustic barrier mat* ensuring low breakout noise levels. The unit and attenuators shall be supplied complete with suspension brackets for inclusion into a drop rod mounting system.

The unit shall incorporate a high efficiency aluminium counterflow plate heat exchanger matrix with a thermal efficiency of up to 96%, fitted with a segmented 100% bypass facility and patented actuator operating under automatic control. The automatic operation of the XBC bypass is determined by an algorithm that varies output based on temperatures, and whether the control system has been set to prioritise heating, ventilation or cooling. All elements of the unit shall be protected from airborne contamination by high capacity pleated G4 panel filters (supply and extract). Two spare filters are provided for post-construction phase fitting.

The unit shall be fitted with ErP 2018 rated, low energy, high efficiency IP54 EC motorised fans providing low specific fan powers and stepless speed control, without tonal noise generation. Fan/motor assemblies have sealed for life bearings with an anticipated working life of 70,000 hours (L10) and shall be suitable for single phase supply.

Impellers shall be of high efficiency, performance and sound optimised backward curved design.

The unit shall be fitted with either an Electric heater battery (code example XBC15-H-EES) with burst fired temperature controller; or a LPHW heater battery (code example XBC15-H-LES), complete with factory fitted valve and actuator, terminating at the unit casing.

The system shall have frost protection (Ecosmart models only) which shall, at temperatures below 4 degrees C, fully open the 4-port valve and only start the fan when the temperature within the chamber has risen above the designated set point.

The LPHW assembly shall be pressure tested at works to a minimum of 6 Bar. The control for the heaters shall be fully integrated and shall maintain a constant temperature*** to meet the system design requirements.

***The heating output (LPHW or electric) is automatically regulated to control the Air - Off condition.

The unit is also available without a heater fitted (code example XBC15-H-NBC).

*Note: XBC10 contains specialist acoustic treatment and has G3 panel filter (supply and extract).

The unit shall be constructed with removable side panels allowing maintenance access with minimal service space clearance required.

The removable panels shall provide access to the following:-

- Supply and extract fan.
- Supply and extract filter.
- Condensate tray.
- All control adjustments (where included).

Bottom access variants are available (for filter only).

UNIT CONFIGURATION

Supply/discharge airflow connections are on the unit centreline; Intake/Extract connections are configurable on site to either side of the unit. Unit is supplied as configuration A as standard (refer to technical documentation).

The ventilation unit shall comprise the following:-

Supply and extract fans, high efficiency counterflow plate heat exchanger matrix, supply and extract filters, full 100% automatic heat exchanger bypass, heating coil (as selected) & condensate drip tray, a condensate pump is installed in the unit and has an alarm function (connection by others). If the water level in the condensate tray exceeds a maximum level (for example, as a result of the discharge tube becoming blocked or frozen), the alarm contact will open. This contact is internally connected to the heat exchanger bypass actuator, and the unit will automatically be placed into bypass mode, preventing further condensate production. Unit operation will otherwise be unaffected.

Matching high mass double skinned wall construction attenuators can also be provided by Nuair.

CODE DESCRIPTION

XBC15-H-LES-R-BA
| | | | | | | |
1 2 3 4 5 6 7 8

1. XBOXER
2. Counterflow heat exchanger
3. Unit size
4. H = Horizontal
5. Type of heater battery:
L = LPHW, E = Electric, N = No heater
6. Control type:
AT = Ecosmart Adapt (Trend)
CO = Ecosmart Connect
ES = Ecosmart Classic
BC = Basic control
7. R = Opposite configuration
8. BA = Bottom access for filter removal (XBC10-45 units only)

For further details on the ErP directive please refer to www.nuaire.co.uk

XBC10-65 CONTROL OPTIONS

CONSULTANTS SPECIFICATION

BASIC CONTROL OPTION

Unit is provided with side access terminal boxes for direct supply and extract fan motor wiring and for interfacing to custom built control panels.

The control assembly is side mounted with a 90° rotation facility for wiring and commissioning adjustments in restricted access conditions. (260mm access allowance is required).

A side mounted terminal box is provided for the connections to the fans (230V 50Hz LNE and 2-10V), and Electric heater terminal and thermal protection (where specified).

For this option, no sensors are fitted to the unit, but note that the plate heat exchanger bypass damper actuator is included suitable for 230V standard (24V available).

Units fitted with Basic Control (code example XBC25-H-EBC) have a 2 year warranty.

ECOSMART CLASSIC OPTION - DEMAND CONTROLLED VENTILATION

Provides the facility for energy saving via an intelligent stand-alone AHU function with local diagnostic status indication, or allows convenient integration with the client BMS with a minimal co-ordination requirement.

The factory fitted Ecosmart Classic control includes:- integral infinitely variable speed / duty control for the supply and extract fans, with independent minimum, maximum and offset adjustment (up to 40%) for accurate commissioning.

The control assembly is side mounted with a 90° rotation facility for wiring and commissioning adjustments in restricted access conditions. (260mm access allowance is required).

The control features a run on timer and "background" ventilation function, and is provided with unit status indication, run and fail relays and interface connections for Ecosmart Classic sensors/enablers and system dampers.

The heat exchanger bypass is automatically operated according to temperature and a pre-defined strategy.

***The heating output (LPHW or electric) is automatically regulated to control the Air - Off condition.

The Ecosmart control module can additionally be connected to provide the following integrated BMS interfaces.

- 0 - 10 volt inputs. This will enable the following functions:- Switch the unit ON/OFF. Variable speed / duty control, Switch from low speed to high speed, Enable heating/cooling.
- 2 No. Volt free contacts give fan run and failure unit status indication.

Units fitted with Ecosmart Classic control (code example XBC15-H-LES) have a 5 year warranty.

ECOSMART CONNECT OPTION – ENHANCED DEMAND CONTROLLED VENTILATION

A comprehensive unit control specification - factory fitted and tested to provide guaranteed operation from a single supplier – one who will take responsibility.

The unit integrated Ecosmart Connect system provides the facility for operational efficiency and energy saving by allowing a comprehensive range of unitary control functions and / or full BMS integration (by others) via standard BACnet (MS/TP).

The system incorporates a web access enabled controller, and is augmented by application specific unit interface and diagnostic circuits. Controller software is optimised and pre-configured, and each unit / control assembly is fully functionally tested at works (Refer to technical documentation for full controller functional specification).

Units fitted with Ecosmart Connect control (code example XBC45-H-CO) have a 5 year warranty. (Refer to 'Description of control' for further details).

ECOSMART ADAPT WITH TREND OPTION – ENHANCED DEMAND CONTROLLED VENTILATION

A comprehensive unit control specification - factory fitted and tested to provide guaranteed operation from a single supplier – one who will take responsibility.

The unit integrated Ecosmart Adapt system provides the facility for operational efficiency and energy saving by allowing a comprehensive range of unitary control functions and / or full BMS integration (by others) via standard BACnet IP configuration.

The system incorporates a web access enabled Trend IQ422/12/LAN/BAC/230 controller, and is augmented by application specific unit interface and diagnostic circuits. Controller software is optimised and pre-configured, and each unit / control assembly is fully functionally tested at works (Refer to technical documentation for full controller functional specification).

Units fitted with Ecosmart Adapt control (code example XBC45-H-LAT) have a 5 year warranty. (Refer to 'Description of control' for further details).

The unit shall be the XBC10-65 as manufactured by Nuaire.

XBC10-65 HORIZONTAL HEAT EXCHANGE UNITS

UNIT WIRING

WIRING - FOR UNITS SUPPLIED WITHOUT ECOSMART CLASSIC CONTROL (EXAMPLE CODING XBC45-H-LBC)

The wiring illustrations below are for the fans, bypass damper and electric heater for units without control.

Note that any heating/cooling coils fitted are supplied without control valve and actuator.

Note: Do not wire the power supply to motor via motor thermal overload as these are only closed after the motor is energized.

Thermal overload contact rating is 2A max resistive.

Note: The Alarm relay on condensate may require the use of a contactor if the host equipment supply is to be switched.

ELECTRIC HEATER XBC25-65 ONLY

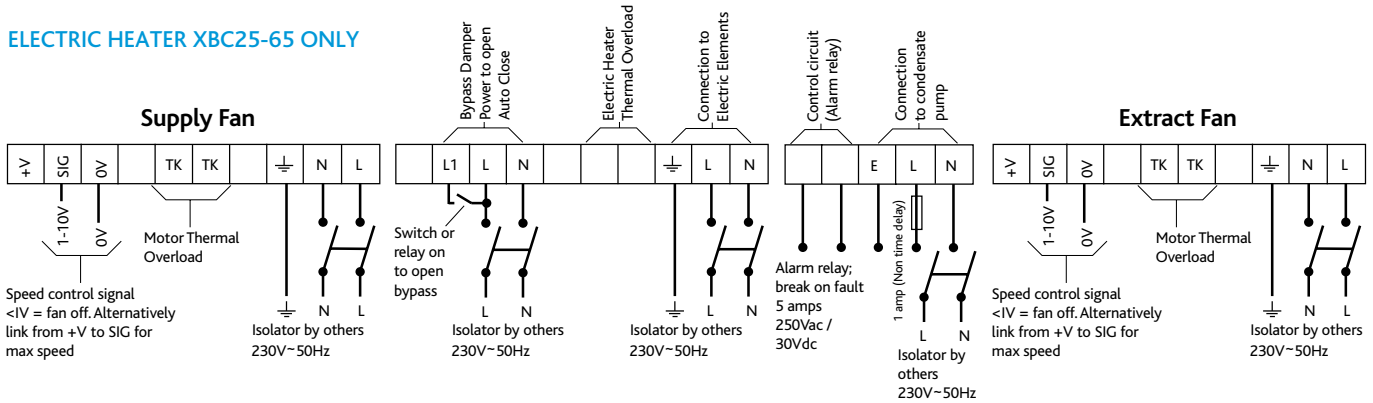

ELECTRIC HEATER XBC10-15 ONLY

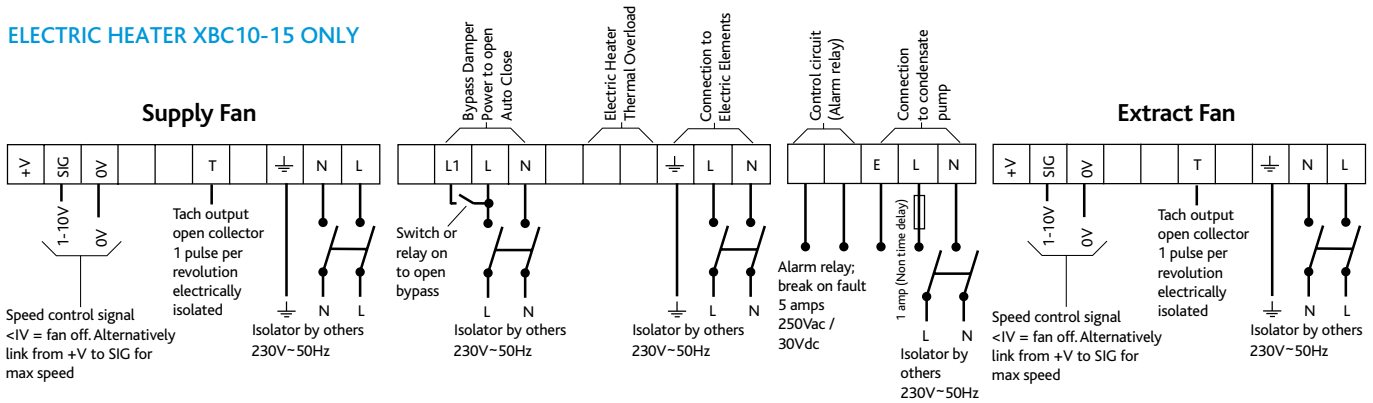

LPHW & NO HEATER XBC25-65 ONLY

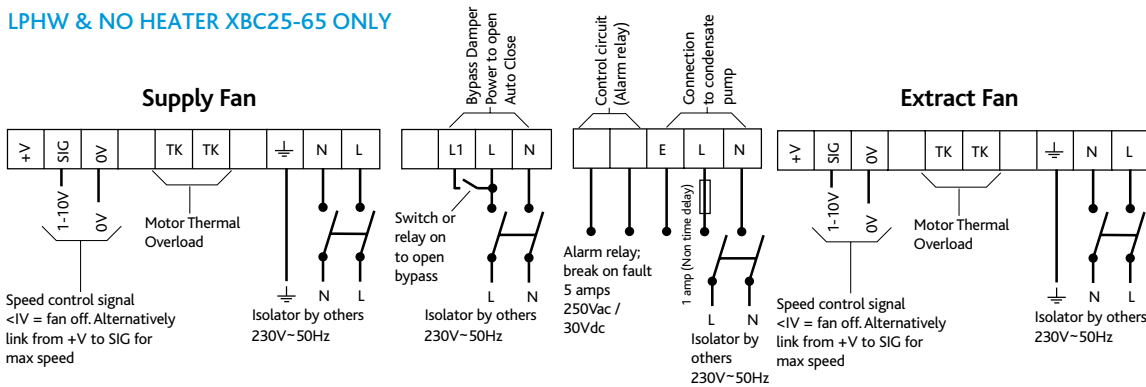

LPHW & NO HEATER XBC10-15 ONLY

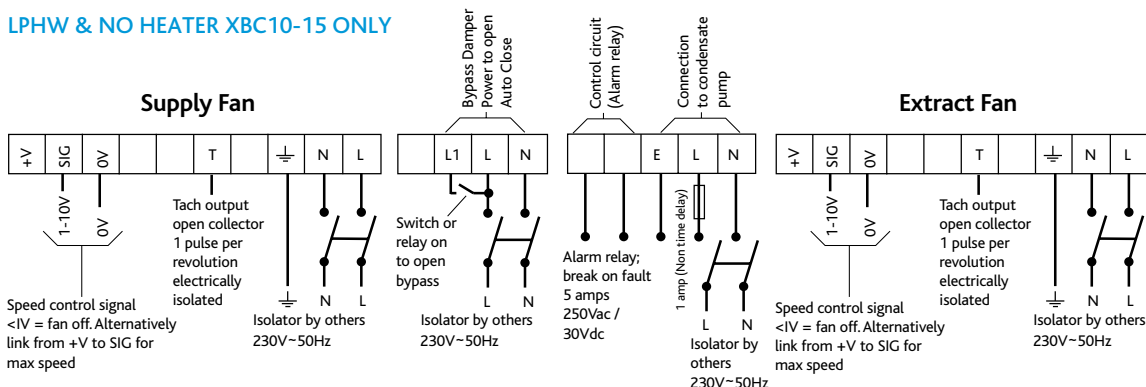

XBC10-65 HORIZONTAL HEAT EXCHANGE UNITS

UNIT WIRING

UNITS WITH ECOSMART CLASSIC CONTROL & LPHW COIL CONTROL (CODING EXAMPLE XBC15-H-LES)

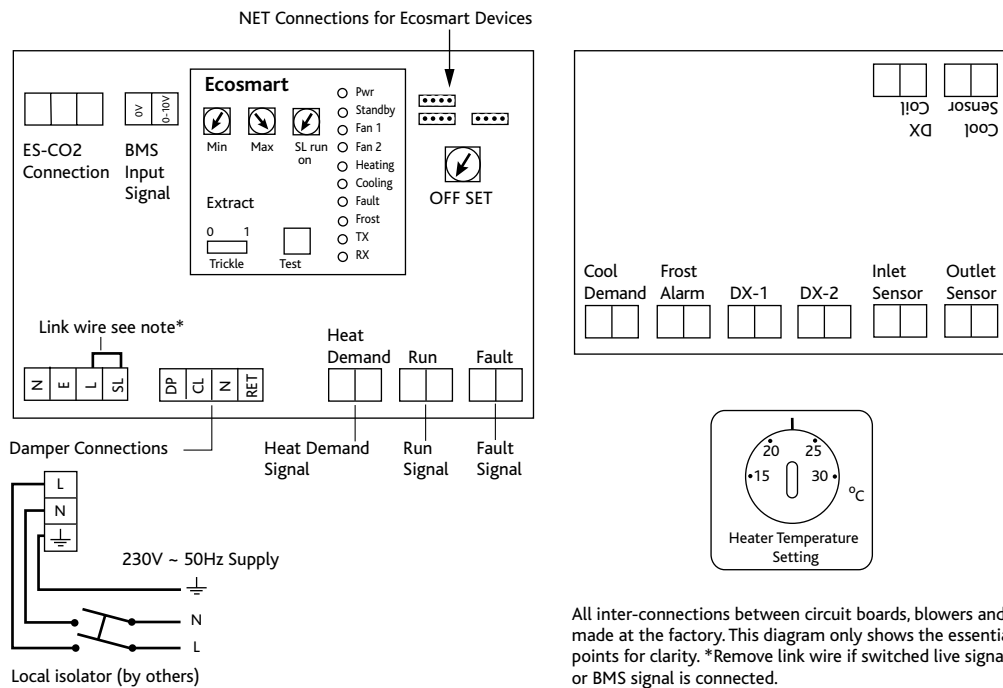

All inter-connections between circuit boards, blowers and sensors are made at the factory. This diagram only shows the essential field wiring points for clarity. *Remove link wire if switched live signal, an enabler or BMS signal is connected.

UNITS WITH ECOSMART CLASSIC CONTROL & ELECTRIC HEATER (CODING EXAMPLE XBC45-H-EES)

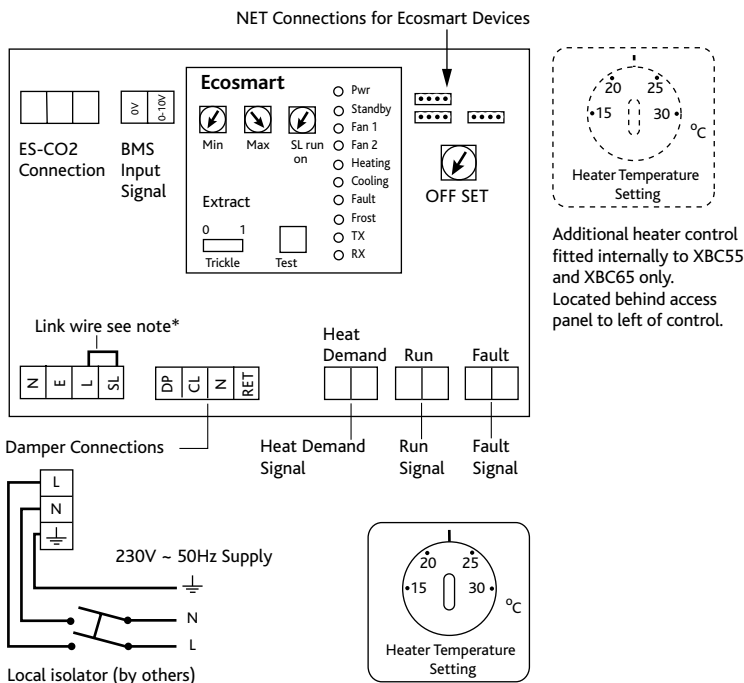

All inter-connections between circuit boards, blowers and sensors are made at the factory. This diagram only shows the essential field wiring points for clarity. *Remove link wire if switched live signal, an enabler or BMS signal is connected.

UNITS WITH ECOSMART CLASSIC FAN ONLY CONTROL (CODING EXAMPLE XBC25-H-NES)

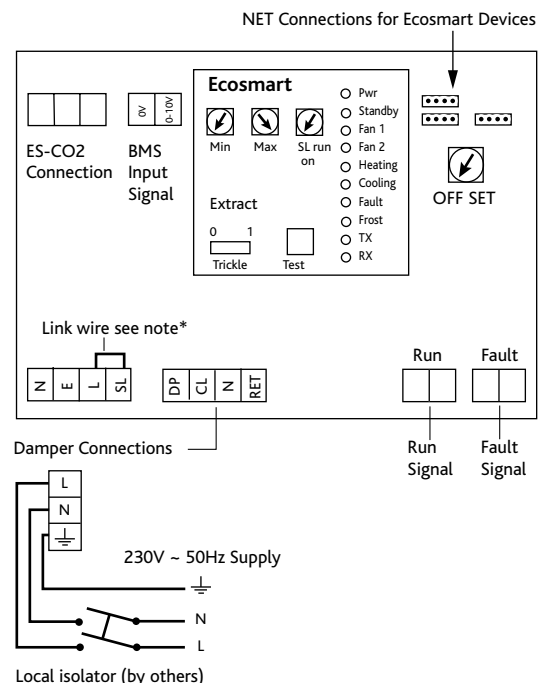

All inter-connections between circuit boards, blowers and sensors are made at the factory. This diagram only shows the essential field wiring points for clarity. *Remove link wire if switched live signal, an enabler or BMS signal is connected.

ECOSMART WIRING For Ecosmart Connect and Adapt Trend wiring please contact Nuair.

XBC75 HORIZONTAL HEAT EXCHANGE UNITS

PERFORMANCE & TECHNICAL INFORMATION

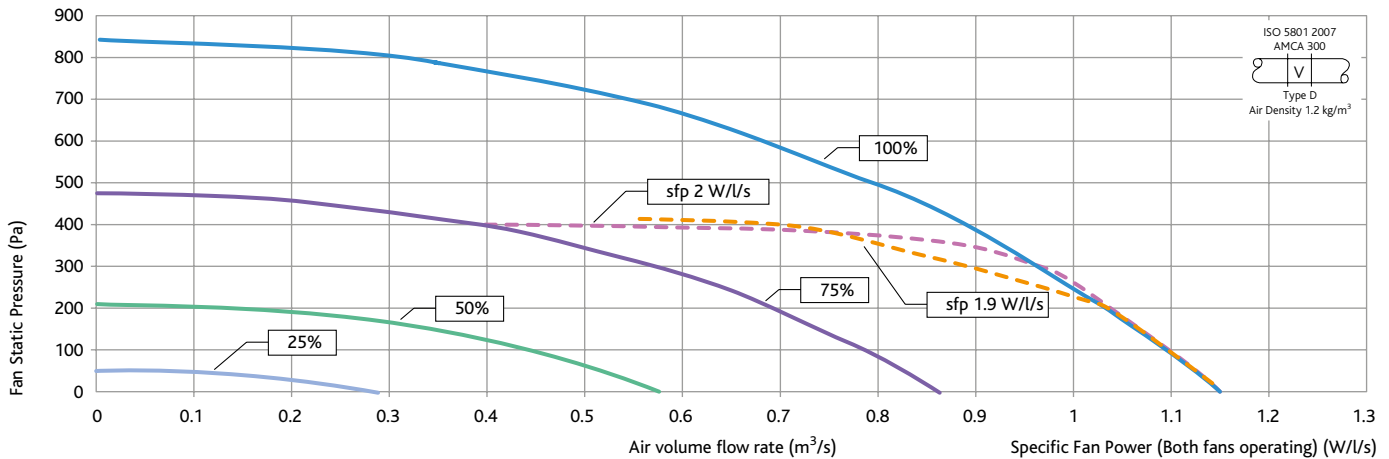

XBC75 HORIZONTAL UNIT PERFORMANCE

| Fan Speed | External Static Pressure (Pa) | Fan Speed | | | | | | | | Fan Speed | External Static Pressure (Pa) | | | | | | | | | | | |
|-----------|-------------------------------|-----------|------|------|------|------|------|------|------|-----------|-------------------------------|-----------------------------|--------------|------|------|-----|-----|-----|-----|--|--|--|
| | | 0 | 50 | 100 | 200 | 300 | 400 | 500 | 600 | | | 0 | 50 | 100 | 200 | 300 | 400 | 500 | 600 | | | |
| 100% | Airflow (m ³ /s) | 1.15 | 1.13 | 1.10 | 1.04 | 0.97 | 0.89 | 0.80 | 0.68 | 50% | Airflow (m ³ /s) | 0.58 | 0.52 | 0.45 | 0.15 | | | | | | | |
| | sfp (W/l/s) | 1.57 | 1.64 | 1.74 | 1.90 | 2.06 | 2.22 | 2.41 | 2.74 | | sfp (W/l/s) | 0.38 | 0.47 | 0.55 | 1.36 | | | | | | | |
| | dBa@3m | 41 | | | | | | | | | dBa@3m | 26 | | | | | | | | | | |
| 75% | Airflow (m ³ /s) | 0.86 | 0.83 | 0.78 | 0.69 | 0.57 | 0.38 | | | | 25% | Airflow (m ³ /s) | 0.29 | | | | | | | | | |
| | sfp (W/l/s) | 0.89 | 0.97 | 1.07 | 1.21 | 1.41 | 2.01 | | | | | sfp (W/l/s) | 0.2 (approx) | | | | | | | | | |
| | dBa@3m | 35 | | | | | | | | dBa@3m | | <20 | | | | | | | | | | |

Specific Fan Power figures are the total for both fans operating.

For accurate figures, please refer to Nuair Fan Selection Programme at www.nuair.co.uk

| Unit Code | Voltage / Phase / Frequency | Input Power (W) | FLC / SC (A) | Max Operating Temperature | Fan Speed (rpm) | Unit Weight [†] (kg) | Packed Weight [†] (kg) | Pallet / crate dimensions (mm) | | |
|-------------|-----------------------------|-----------------|--------------|---------------------------|-----------------|-------------------------------|---------------------------------|--------------------------------|-------|-------|
| | | | | | | | | 3000L | 2600W | 1041H |
| XBC75-H-L** | 400 / 3 / 50 | 2100 | 3.5 / 3.5 | 40°C | 2140 | 650 | 740 | 3000L | 2600W | 1041H |
| XBC75-H-E** | 400 / 3 / 50 | 14100* | 21 / 21 | 40°C | 2140 | 650 | 740 | 3000L | 2600W | 1041H |
| XBC75-H-N** | 400 / 3 / 50 | 2100 | 3.5 / 3.5 | 40°C | 2140 | 650 | 740 | 3000L | 2600W | 1041H |

**Add relevant code ie: BC, ES, CO or AT for control type.

*Includes 12kW Electric Heater.

Add 'R' to relevant code for opposite configuration ie: XBC75-H-LES-R.

† Internal units only. For weatherproof units, add 65kg.

FAN UNIT DIMENSIONS (mm)

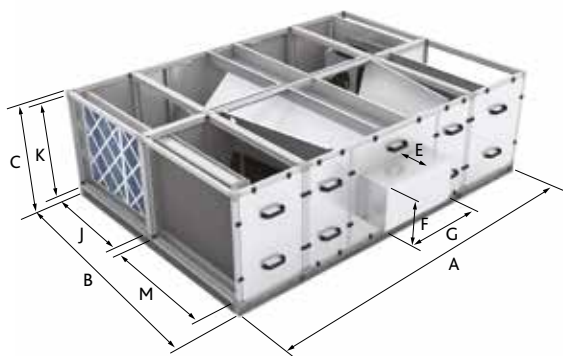

XBC75 HORIZONTAL FAN CONFIGURATION

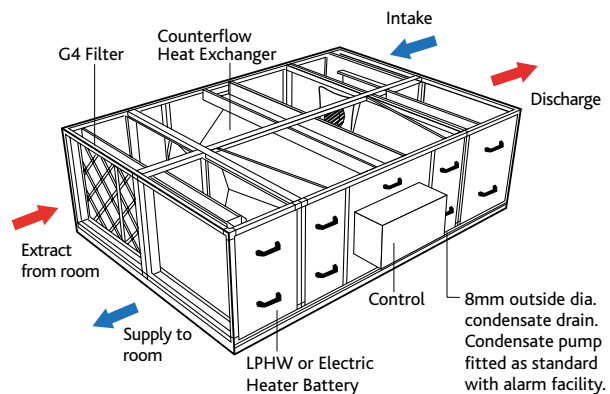

| Fan Unit Dimensions (mm) | | | Control for all Models Dimensions (mm) | | | Rectangular Aperture Dimensions (mm) | | | Weather Roof for | | | Service & Maintenance Requirements | |
|--------------------------|------|------|--|-----|-----|--------------------------------------|-----|-----|------------------|------|------|------------------------------------|---|
| A | B | C | E | F | G | J | K | M | H | x | W | | x |
| 2800 | 2126 | 876* | 250 | 730 | 800 | 940 | 740 | 940 | 125 | 2126 | 2800 | | |

The unit is designed for side access as standard and must be installed with a minimum of 650mm clearance from a wall or barrier. This will provide access to filters, coil, fan, heat exchanger, condensate tray and pump.

All models - the weather roof is part of the unit code and is factory fitted only. Example: XBC75-H-LESWP.

*Includes unit and base rail.

XBC75 VERTICAL HEAT EXCHANGE UNITS

PERFORMANCE & TECHNICAL INFORMATION

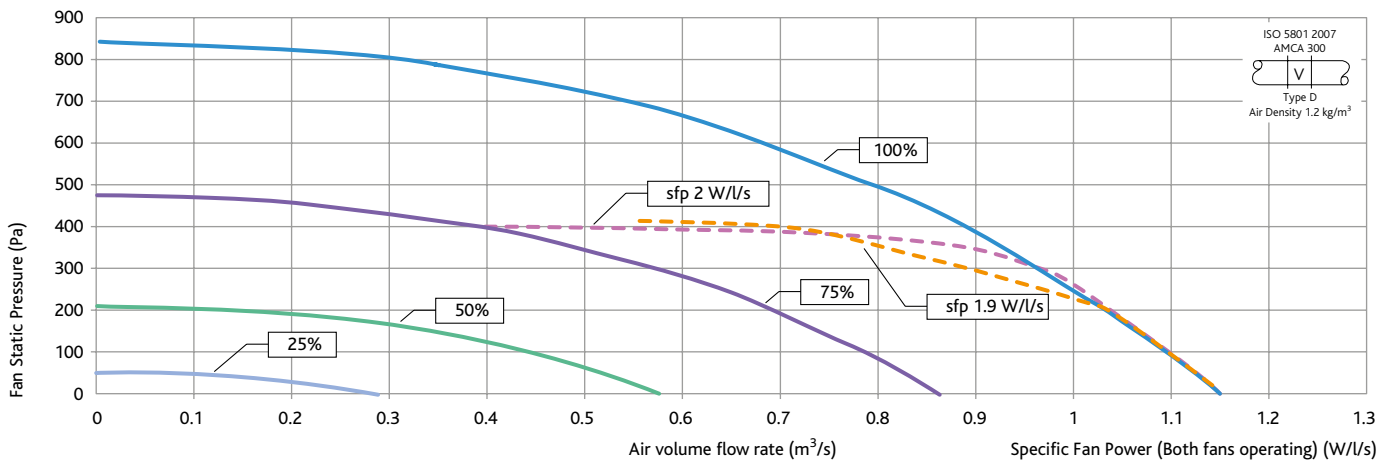

XBC75 VERTICAL UNIT PERFORMANCE

| Fan Speed | | External Static Pressure (Pa) | | | | | | | | Fan Speed | | External Static Pressure (Pa) | | | | | | | | | |
|-----------|----------------|-------------------------------|------|------|------|------|------|------|------|-----------|----------------|-------------------------------|------|------|----------------|--------------|-----|-----|-----|--|--|
| | | 0 | 50 | 100 | 200 | 300 | 400 | 500 | 600 | | | 0 | 50 | 100 | 200 | 300 | 400 | 500 | 600 | | |
| 100% | Airflow (m³/s) | 1.15 | 1.13 | 1.10 | 1.04 | 0.97 | 0.89 | 0.80 | 0.68 | 50% | Airflow (m³/s) | 0.58 | 0.52 | 0.45 | 0.15 | | | | | | |
| | sfp (W/l/s) | 1.57 | 1.64 | 1.74 | 1.90 | 2.06 | 2.22 | 2.41 | 2.74 | | sfp (W/l/s) | 0.38 | 0.47 | 0.55 | 1.36 | | | | | | |
| | dBA@3m | 36 | | | | | | | | | dBA@3m | 21 | | | | | | | | | |
| 75% | Airflow (m³/s) | 0.86 | 0.83 | 0.78 | 0.69 | 0.57 | 0.38 | | | | | | | 25% | Airflow (m³/s) | 0.29 | | | | | |
| | sfp (W/l/s) | 0.89 | 0.97 | 1.07 | 1.21 | 1.41 | 2.01 | | | | | | | | sfp (W/l/s) | 0.2 (approx) | | | | | |
| | dBA@3m | 30 | | | | | | | | dBA@3m | <20 | | | | | | | | | | |

Specific Fan Power figures are the total for both fans operating.

For accurate figures, please refer to Nuair Fan Selection Programme at www.nuair.co.uk

| Unit Code | Voltage / Phase / Frequency | Input Power (W) | FLC / SC (A) | Max Operating Temperature | Fan Speed (rpm) | Unit Weight† (kg) | Packed Weight† (kg) | Pallet / crate dimensions (mm) |
|-------------|-----------------------------|-----------------|--------------|---------------------------|-----------------|-------------------|---------------------|--------------------------------|
| XBC75-V-L** | 400 / 3 / 50 | 2100 | 3.5 / 3.5 | 40°C | 2140 | 547 | 597 | 2800L x 1200W x 1581H |
| XBC75-V-E** | 400 / 3 / 50 | 14100* | 21 / 21 | 40°C | 2140 | 547 | 597 | 2800L x 1200W x 1581H |
| XBC75-V-N** | 400 / 3 / 50 | 2100 | 3.5 / 3.5 | 40°C | 2140 | 547 | 597 | 2800L x 1200W x 1581H |

**Add relevant code ie: BC, ES, CO or AT for control type.

*Includes 12kW Electric Heater.

Add 'R' to relevant code for opposite configuration ie: XBC75-V-LES-R.

† Internal units only. For weatherproof units, add 28kg.

FAN UNIT DIMENSIONS (mm)

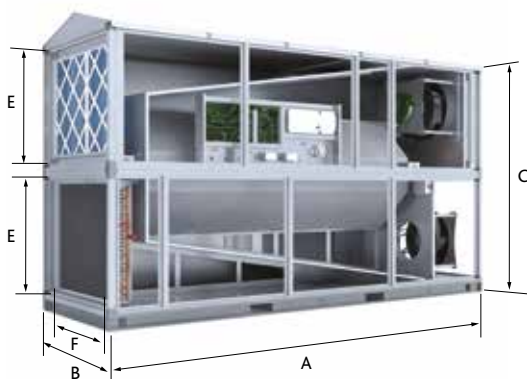

XBC75 FAN CONFIGURATION

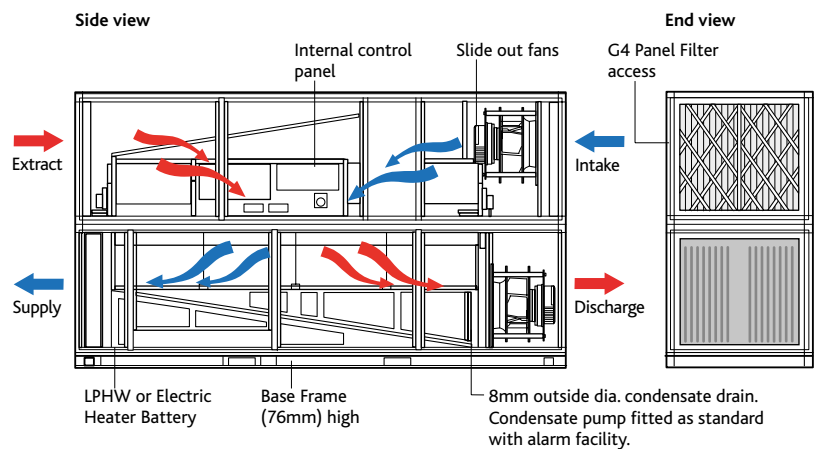

| Fan Unit Dimensions (mm) | | | Rectangular Aperture (mm) | | Weather Roof (All models) Code: XBC75-V-LESWP (mm) | | Service & Maintenance Requirements |
|--------------------------|-----|-------|---------------------------|-----|--|--|------------------------------------|
| A | B | C | E | F | H x W x L | | |
| 2500 | 954 | 1416* | 610 | 894 | 60 x 954 x 2500 | | |

Weather roof is factory fitted only. Code example XBC75-V-LESWP.

*Includes base frame (76mm) high.

Service & Maintenance Requirements
The unit is designed for side access as standard and must be installed with a minimum of clearance of 650mm from a wall or barrier. This will provide access to filters, coil, fan, heat exchanger, condensate tray and pump.

XBC85 HORIZONTAL HEAT EXCHANGE UNITS

PERFORMANCE & TECHNICAL INFORMATION

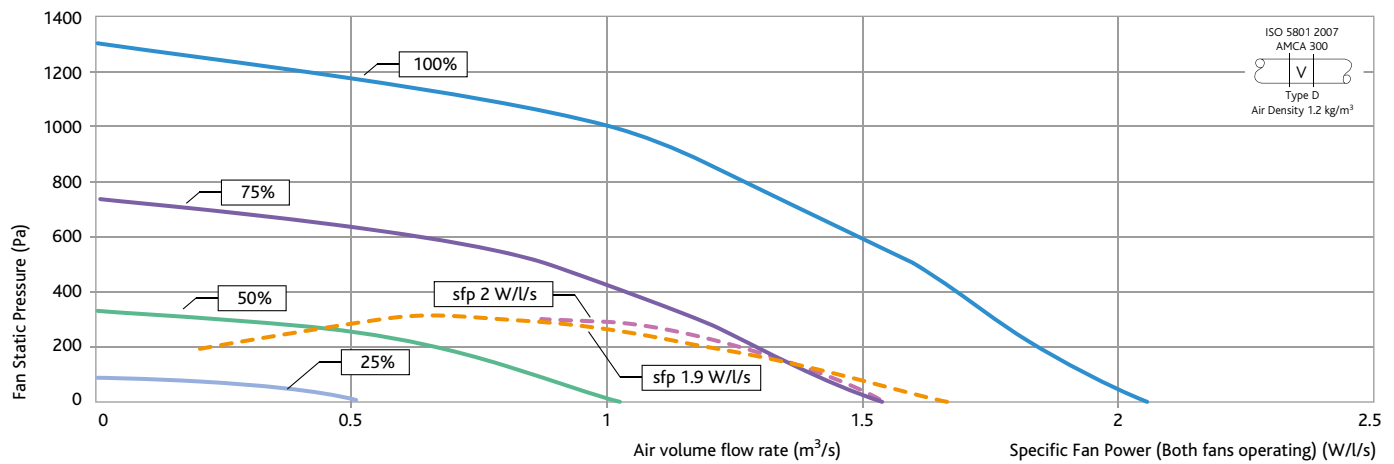

XBC85 HORIZONTAL UNIT PERFORMANCE

| Fan Speed | | External Static Pressure (Pa) | | | | | | | | Fan Speed | | External Static Pressure (Pa) | | | | | | | | | | |
|-----------|----------------|-------------------------------|------|------|------|------|------|------|------|-----------|----------------|-------------------------------|------|------|------|------|-----|-----|-----|--|--|--|
| | | 0 | 50 | 100 | 150 | 200 | 300 | 400 | 500 | | | 0 | 50 | 100 | 150 | 200 | 300 | 400 | 500 | | | |
| 100% | Airflow (m³/s) | 2.05 | 1.99 | 1.94 | 1.89 | 1.84 | 1.76 | 1.68 | 1.60 | 50% | Airflow (m³/s) | 1.02 | 0.93 | 0.83 | 0.72 | 0.61 | | | | | | |
| | sfp (W/l/s) | 2.84 | 2.94 | 3.05 | 3.14 | 3.23 | 3.42 | 3.64 | 3.94 | | sfp (W/l/s) | 0.70 | 0.80 | 0.92 | 1.10 | 1.30 | | | | | | |
| | dBa@3m | 50 | | | | | | | | | dBa@3m | 35 | | | | | | | | | | |
| 75% | Airflow (m³/s) | 1.54 | 1.47 | 1.40 | 1.34 | 1.28 | 1.14 | 1.00 | | | Airflow (m³/s) | 0.51 | 0.30 | | | | | | | | | |
| | sfp (W/l/s) | 1.60 | 1.69 | 1.80 | 1.88 | 2.02 | 2.30 | 2.71 | | | sfp (W/l/s) | 0.20 | 0.30 | | | | | | | | | |
| | dBa@3m | 44 | | | | | | | | | | dBa@3m | 20 | | | | | | | | | |

Specific Fan Power figures are the total for both fans operating.

For accurate figures, please refer to Nuair Fan Selection Programme at www.nuair.co.uk

| Unit Code | Voltage / Phase / Frequency | | Input Power (W) | FLC / SC (A) | Max Operating Temperature | Fan Speed (rpm) | Unit Weight (kg) | Packed Weight (kg) | Pallet / crate dimensions (mm) |
|-------------|-----------------------------|--|-----------------|--------------|---------------------------|-----------------|------------------|--------------------|--------------------------------|
| | | | | | | | | | |
| XBC85-H-L** | 400 / 3 / 50 | | 6000 | 9.5 / 9.5 | 40°C | 2550 | 760 | 942 | 3000L x 2600W x 1041H |
| XBC85-H-E** | 400 / 3 / 50 | | 24000* | 35 / 35 | 40°C | 2550 | 760 | 942 | 3000L x 2600W x 1041H |
| XBC85-H-N** | 400 / 3 / 50 | | 6000 | 9.5 / 9.5 | 40°C | 2550 | 760 | 942 | 3000L x 2600W x 1041H |

**Add relevant code ie: BC, ES, CO or AT for control type.

*Includes 18kW Electric Heater.

Add 'R' to relevant code for opposite configuration ie: XBC85-H-LES-R.

FAN UNIT DIMENSIONS (mm)

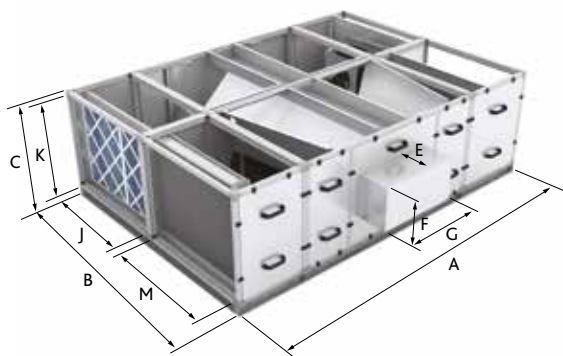

XBC85 HORIZONTAL FAN CONFIGURATION

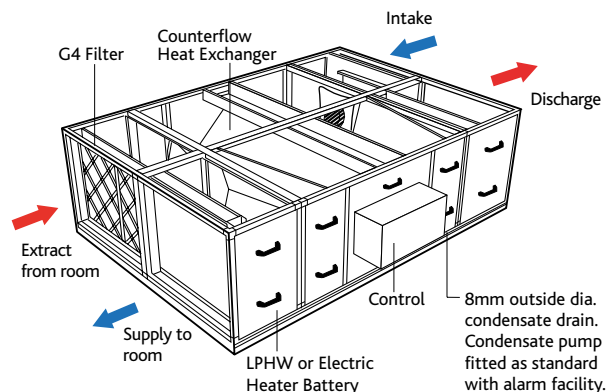

| Fan Unit Dimensions (mm) | | | Control for all Models Dimensions (mm) | | | Rectangular Aperture Dimensions (mm) | | | Weather Roof for | | | Service & Maintenance Requirements | |
|--------------------------|------|------|--|-----|-----|--------------------------------------|-----|-----|------------------|---|------|------------------------------------|------|
| A | B | C | E | F | G | J | K | M | H | x | W | | x |
| 2800 | 2126 | 876* | 250 | 730 | 800 | 940 | 740 | 940 | 125 | | 2126 | | 2800 |

The unit is designed for side access as standard and must be installed with a minimum of 650mm clearance from a wall or barrier. This will provide access to filters, coil, fan, heat exchanger, condensate tray and pump.

All models - the weather roof is part of the unit code and is factory fitted only. Example: XBC85-H-LESWP.

*Includes unit and base rail.

XBC85 HORIZONTAL HEAT EXCHANGE UNITS

PERFORMANCE & TECHNICAL INFORMATION

XBC85 HORIZONTAL FAN - SOUND DATA

| Fan Speed | Sound Power Levels (dB re 1 pW) | Frequency (Hz) | | | | | | | | Spherical dBA@3m | Fan Speed | External Static Pressure (Pa) | | | | | | | | Spherical dBA@3m |
|-----------|---------------------------------|----------------|-----|-----|-----|------|------|------|------|------------------|-----------|-------------------------------|-----|-----|-----|------|------|------|------|------------------|
| | | 63 | 125 | 250 | 500 | 1000 | 2000 | 4000 | 8000 | | | 63 | 125 | 250 | 500 | 1000 | 2000 | 4000 | 8000 | |
| 100% | Induct Intake | 84 | 85 | 89 | 88 | 85 | 82 | 77 | 73 | 52 | 50% | 69 | 70 | 74 | 73 | 70 | 67 | 62 | 58 | 37 |
| | Induct Supply | 85 | 82 | 84 | 84 | 81 | 75 | 63 | 50 | | | 70 | 67 | 69 | 69 | 66 | 60 | 48 | 35 | |
| | Induct Discharge | 94 | 94 | 95 | 94 | 96 | 91 | 85 | 77 | | | 79 | 79 | 80 | 79 | 81 | 76 | 70 | 62 | |
| | Induct Extract | 86 | 79 | 84 | 82 | 78 | 74 | 66 | 65 | | | 71 | 64 | 69 | 67 | 63 | 59 | 51 | 50 | |
| | Casing Radiated | 84 | 76 | 80 | 69 | 63 | 58 | 60 | 48 | | | 69 | 61 | 65 | 54 | 48 | 43 | 45 | 33 | |
| 75% | Induct Intake | 78 | 79 | 83 | 82 | 79 | 76 | 71 | 67 | 46 | 25% | 57 | 58 | 62 | 61 | 58 | 55 | 50 | 46 | 25 |
| | Induct Supply | 79 | 76 | 78 | 78 | 75 | 69 | 57 | 44 | | | 58 | 55 | 57 | 57 | 54 | 48 | 36 | 23 | |
| | Induct Discharge | 88 | 88 | 89 | 88 | 90 | 85 | 79 | 71 | | | 67 | 67 | 68 | 67 | 69 | 64 | 58 | 50 | |
| | Induct Extract | 80 | 73 | 78 | 76 | 72 | 68 | 60 | 59 | | | 59 | 52 | 57 | 55 | 51 | 47 | 39 | 38 | |
| | Casing Radiated | 78 | 70 | 74 | 63 | 57 | 52 | 54 | 42 | | | 57 | 49 | 53 | 42 | 36 | 31 | 33 | 21 | |

*Casing Radiated (Breakout).

ATTENUATOR (SIDE BY SIDE) DIMENSIONS (mm), DYNAMIC INSERTION LOSS (dB) & WEIGHTS (kg)

| Attenuator* Code | Attenuator Dimensions | | | Dynamic Insertion Loss (dB) | | | | | | | | Attenuator Weight (kg) | Packed Weight (kg) |
|------------------|-----------------------|-------|----------|-----------------------------|-----|-----|-----|------|------|------|------|------------------------|--------------------|
| | Length | Width | Height** | 63 | 125 | 250 | 500 | 1000 | 2000 | 4000 | 8000 | | |
| XBC85-H-SIL900 | 900 | 2000 | 876 | 0 | 6 | 8 | 18 | 22 | 20 | 16 | 15 | 185 | 190 |
| XBC85-H-SIL900WP | 900 | 2000 | 1001 | 0 | 6 | 8 | 18 | 22 | 20 | 16 | 15 | 190 | 195 |

*Attenuator sections are side by side, one piece modules. **Includes 76mm base frame.

COUNTERFLOW HEAT EXCHANGER EFFICIENCY (%)

Performance based on:
Indoor Conditions 21 Deg C / 50 % RH

Key to performance curves

- Intake Temperature (Deg C)
- 5 Deg C Intake Typically Specified Values
- 3 Deg C Intake Typically Specified Values
- 1 Deg C Intake Typically Specified Values
- 6 Deg C Approx. Average outdoor temperature (UK heating season)

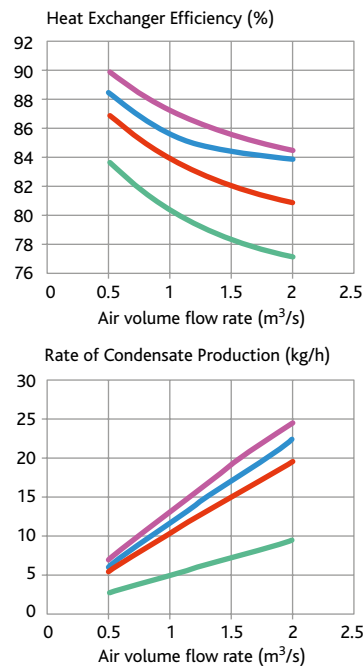

HEATING COIL DATA LPHW

| LPHW Deg C | Airflow (m³/s) | Output (kW) | Air Off Temp (C*) | Water flow (l/s) | Coil ΔP (kPa) | Pipe Connection (mm) | Valve ΔP (kPa) | Valve Type |
|------------|----------------|-------------|-------------------|------------------|---------------|----------------------|----------------|------------|
| LPHW 82/71 | 1.5 | 36.3 | 30.0 | 0.81 | 13.1 | 22 | 20 | 2 Port |
| | 1.1 | 31.6 | 33.9 | 0.69 | 9.4 | 22 | 20 | |
| | 0.75 | 24.7 | 37.4 | 0.54 | 5.8 | 22 | 20 | |
| LPHW 80/60 | 1.5 | 29.4 | 26.3 | 0.37 | 2.6 | 22 | 20 | 2 Port |
| | 1.1 | 25.6 | 29.4 | 0.31 | 1.9 | 22 | 20 | |
| | 0.75 | 20.0 | 32.2 | 0.24 | 1.1 | 22 | 20 | |
| LPHW 60/40 | 1.5 | 17.1 | 19.5 | 0.20 | 0.8 | 22 | 20 | 2 Port |
| | 1.1 | 14.8 | 21.2 | 0.17 | 0.6 | 22 | 20 | |
| | 0.75 | 11.6 | 22.9 | 0.13 | 0.4 | 22 | 20 | |

*Nb Limited to 30 Deg C for Ecosmart Units. Data based on 10 Deg C Air On temperature.

XBC75 VERTICAL HEAT EXCHANGE UNITS

PERFORMANCE & TECHNICAL INFORMATION

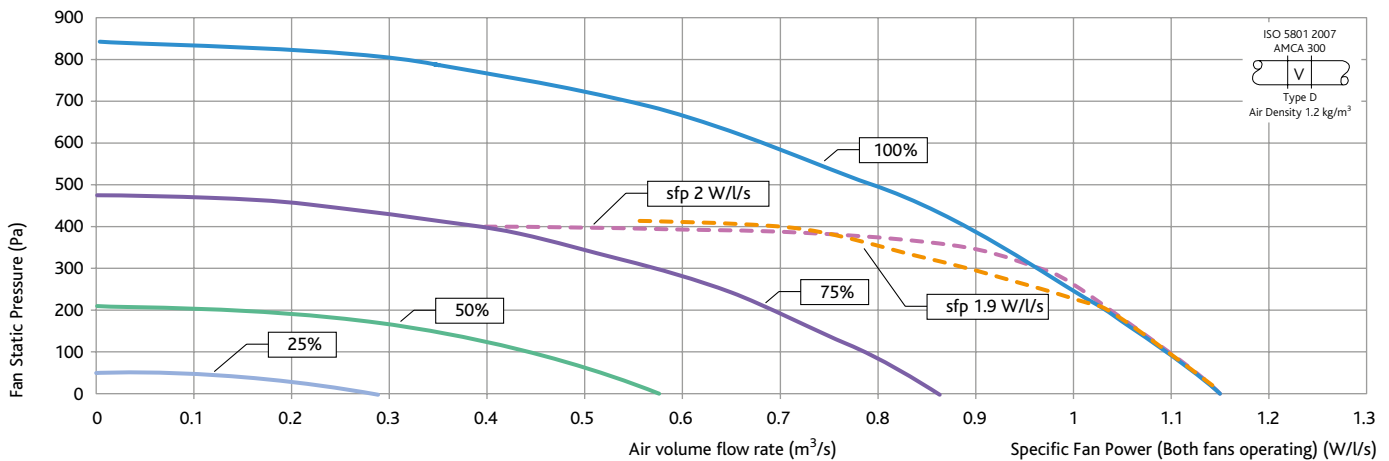

XBC75 VERTICAL UNIT PERFORMANCE

| Fan Speed | External Static Pressure (Pa) | Fan Speed | | | | | | | |
|-----------|-------------------------------|--------------|------|------|------|------|------|------|------|
| | | 0 | 50 | 100 | 200 | 300 | 400 | 500 | 600 |
| 100% | Airflow (m ³ /s) | 1.15 | 1.13 | 1.10 | 1.04 | 0.97 | 0.89 | 0.80 | 0.68 |
| | sfp (W/l/s) | 1.57 | 1.64 | 1.74 | 1.90 | 2.06 | 2.22 | 2.41 | 2.74 |
| | dBA@3m | 36 | | | | | | | |
| 75% | Airflow (m ³ /s) | 0.86 | 0.83 | 0.78 | 0.69 | 0.57 | 0.38 | | |
| | sfp (W/l/s) | 0.89 | 0.97 | 1.07 | 1.21 | 1.41 | 2.01 | | |
| | dBA@3m | 30 | | | | | | | |
| 25% | Airflow (m ³ /s) | 0.58 | 0.52 | 0.45 | 0.15 | | | | |
| | sfp (W/l/s) | 0.38 | 0.47 | 0.55 | 1.36 | | | | |
| | dBA@3m | 21 | | | | | | | |
| 50% | Airflow (m ³ /s) | 0.29 | | | | | | | |
| | sfp (W/l/s) | 0.2 (approx) | | | | | | | |
| | dBA@3m | <20 | | | | | | | |

Specific Fan Power figures are the total for both fans operating.

For accurate figures, please refer to Nuair Fan Selection Programme at www.nuair.co.uk

| Unit Code | Voltage / Phase / Frequency | Input Power (W) | FLC / SC (A) | Max Operating Temperature | Fan Speed (rpm) | Unit Weight (kg) | Packed Weight (kg) | Pallet / crate dimensions (mm) | | |
|-------------|-----------------------------|-----------------|--------------|---------------------------|-----------------|------------------|--------------------|--------------------------------|--|--|
| | | | | | | | | | | |
| XBC75-V-L** | 400 / 3 / 50 | 2100 | 3.5 / 3.5 | 40°C | 2140 | 630 | 722 | 2800L x 1200W x 1581H | | |
| XBC75-V-E** | 400 / 3 / 50 | 14100* | 21 / 21 | 40°C | 2140 | 630 | 722 | 2800L x 1200W x 1581H | | |
| XBC75-V-N** | 400 / 3 / 50 | 2100 | 3.5 / 3.5 | 40°C | 2140 | 630 | 722 | 2800L x 1200W x 1581H | | |

***Add relevant code ie: BC, ES, CO or AT for control type.

*Includes 12kW Electric Heater.

Add 'R' to relevant code for opposite configuration ie: XBC75-V-LES-R.

FAN UNIT DIMENSIONS (mm)

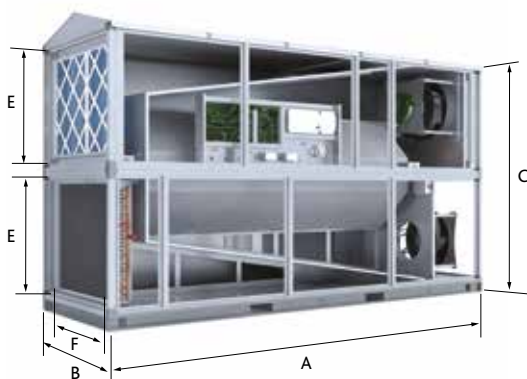

XBC75 FAN CONFIGURATION

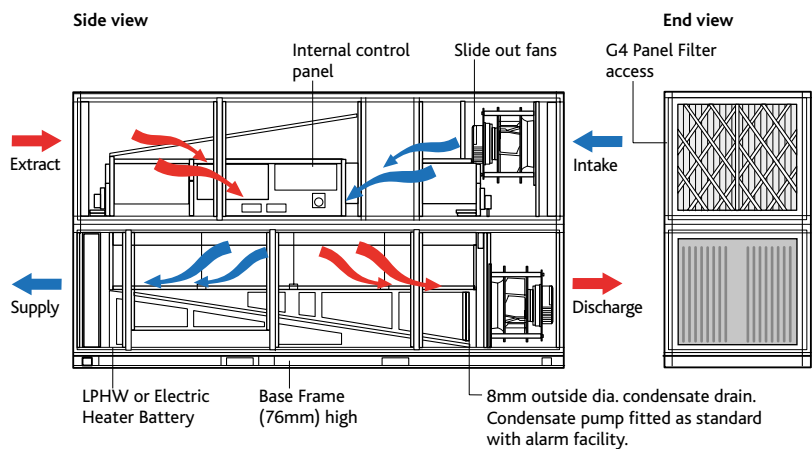

| Fan Unit Dimensions (mm) | | | Rectangular Aperture (mm) | | Weather Roof (All models) Code: XBC75-V-LESWP (mm) | | Service & Maintenance Requirements |
|--------------------------|-----|-------|---------------------------|-----|--|--|------------------------------------|
| A | B | C | E | F | H x W x L | | |
| 2500 | 954 | 1416* | 610 | 894 | 60 x 954 x 2500 | | |

Weather roof is factory fitted only. Code example XBC75-V-LESWP.

*Includes base frame (76mm) high.

The unit is designed for side access as standard and must be installed with a minimum of clearance of 650mm from a wall or barrier. This will provide access to filters, coil, fan, heat exchanger, condensate tray and pump.

XBC75 VERTICAL HEAT EXCHANGE UNITS

PERFORMANCE & TECHNICAL INFORMATION

XBC75 VERTICAL FAN - SOUND DATA

| Fan Speed | Sound Power Levels (dB re 1 pW) | Frequency (Hz) | | | | | | | | Spherical dBA@3m | Fan Speed | External Static Pressure (Pa) | | | | | | | | Spherical dBA@3m |
|-----------|---------------------------------|----------------|-----|-----|-----|------|------|------|------|------------------|-----------|-------------------------------|-----|-----|-----|------|------|------|------|------------------|
| | | 63 | 125 | 250 | 500 | 1000 | 2000 | 4000 | 8000 | | | 63 | 125 | 250 | 500 | 1000 | 2000 | 4000 | 8000 | |
| 100% | Induct Intake | 76 | 75 | 74 | 77 | 70 | 64 | 58 | 54 | 36 | 50% | 61 | 60 | 59 | 62 | 55 | 49 | 43 | 39 | 21 |
| | Induct Supply | 77 | 73 | 67 | 74 | 71 | 61 | 45 | 45 | | | 62 | 58 | 52 | 59 | 56 | 46 | 30 | 30 | |
| | Induct Discharge | 80 | 79 | 74 | 82 | 81 | 73 | 66 | 62 | | | 65 | 64 | 59 | 67 | 66 | 58 | 51 | 47 | |
| | Induct Extract | 74 | 68 | 66 | 68 | 63 | 58 | 59 | 53 | | | 59 | 53 | 51 | 53 | 48 | 43 | 39 | 38 | |
| | Casing Radiated | 70 | 62 | 59 | 57 | 48 | 40 | 54 | 33 | | | 55 | 47 | 44 | 42 | 33 | 25 | 26 | 18 | |
| 75% | Induct Intake | 70 | 69 | 68 | 71 | 64 | 58 | 52 | 48 | 30 | 25% | 49 | 48 | 47 | 50 | 43 | 37 | 31 | 27 | <20 |
| | Induct Supply | 71 | 67 | 61 | 68 | 65 | 55 | 39 | 39 | | | 50 | 46 | 40 | 47 | 44 | 34 | 18 | 18 | |
| | Induct Discharge | 74 | 73 | 68 | 76 | 75 | 67 | 60 | 56 | | | 53 | 52 | 47 | 55 | 54 | 46 | 39 | 35 | |
| | Induct Extract | 68 | 62 | 60 | 62 | 57 | 52 | 48 | 47 | | | 47 | 41 | 39 | 41 | 36 | 31 | 27 | 26 | |
| | Casing Radiated | 64 | 56 | 53 | 51 | 42 | 34 | 35 | 27 | | | 43 | 35 | 32 | 30 | 21 | <20 | <20 | <20 | |

*Casing Radiated (Breakout).

ATTENUATOR DOUBLE DECK DIMENSIONS (mm), DYNAMIC INSERTION LOSS (dB) & WEIGHTS (kg)

| Attenuator* Code | Attenuator Dimensions | | | Dynamic Insertion Loss (dB) | | | | | | | | Attenuator Weight (kg) | Packed Weight (kg) |
|------------------|-----------------------|-------|----------|-----------------------------|-----|-----|-----|------|------|------|------|------------------------|--------------------|
| | Length | Width | Height** | 63 | 125 | 250 | 500 | 1000 | 2000 | 4000 | 8000 | | |
| XBC75-V-SIL900 | 900 | 954 | 1416 | 0 | 6 | 8 | 18 | 22 | 20 | 16 | 15 | 180 | 190 |
| XBC75-V-SIL900WP | 900 | 954 | 1476 | 0 | 6 | 8 | 18 | 22 | 20 | 16 | 15 | 185 | 195 |

*Attenuator sections are double deck, one piece module. **Includes 76mm base frame.

COUNTERFLOW HEAT EXCHANGER EFFICIENCY (%)

Performance based on:
Indoor Conditions 21 Deg C / 50 % RH

Key to performance curves

- Intake Temperature (Deg C)
- 5 Deg C Intake Typically Specified Values
- 3 Deg C Intake Typically Specified Values
- 1 Deg C Intake Typically Specified Values
- 6 Deg C Approx. Average outdoor temperature (UK heating season)

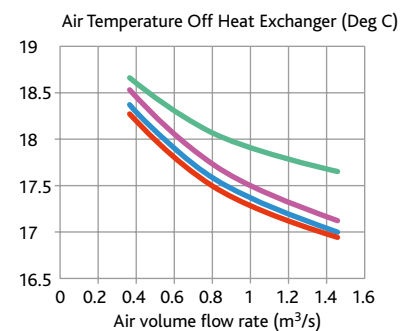
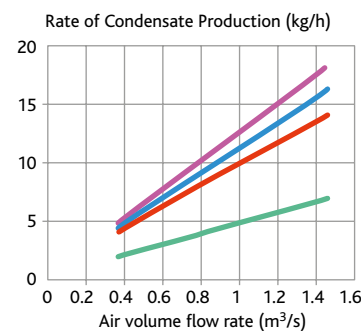
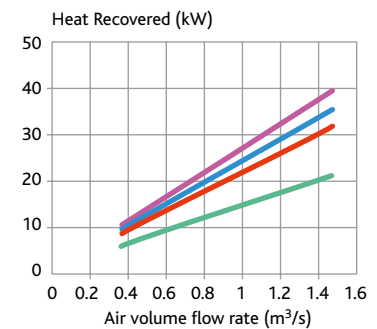
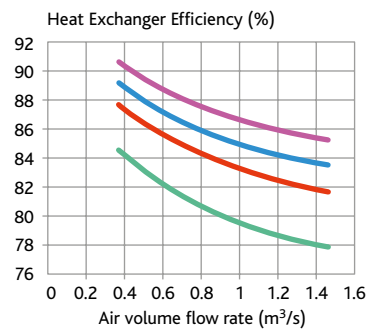

HEATING COIL DATA LPHW

| LPHW Deg C | Airflow (m³/s) | Output (kW) | Air Off Temp (C*) | Water flow (l/s) | Coil ΔP (kPa) | Pipe Connection (mm) | Valve ΔP (kPa) | Valve Type |
|------------|----------------|-------------|-------------------|------------------|---------------|----------------------|----------------|------------|
| LPHW 82/71 | 1.1 | 26.7 | 30.0 | 0.59 | 13.4 | 22 | 20 | 2 Port |
| | 0.83 | 23.2 | 33.3 | 0.51 | 9.7 | 22 | 20 | |
| | 0.55 | 18.2 | 37.5 | 0.39 | 5.9 | 22 | 20 | |
| | 0.275 | 12.3 | 47.4 | 0.27 | 3.8 | 22 | 20 | |
| LPHW 80/60 | 1.1 | 21.6 | 26.4 | 0.27 | 2.6 | 22 | 20 | 2 Port |
| | 0.83 | 18.8 | 28.9 | 0.23 | 1.9 | 22 | 20 | |
| | 0.55 | 14.7 | 32.3 | 0.18 | 1.2 | 22 | 20 | |
| | 0.275 | 10.0 | 40.3 | 0.12 | 0.7 | 22 | 20 | |
| LPHW 60/40 | 1.1 | 12.5 | 19.5 | 0.15 | 0.8 | 22 | 20 | 2 Port |
| | 0.83 | 10.9 | 21.0 | 0.13 | 0.6 | 22 | 20 | |
| | 0.55 | 8.5 | 22.9 | 0.10 | 0.4 | 22 | 20 | |
| | 0.275 | 5.8 | 27.6 | 0.07 | 0.2 | 22 | 20 | |

*Nb Limited to 30 Deg C for Ecosmart Units. Data based on 10 Deg C Air On temperature.

XBC85 VERTICAL HEAT EXCHANGE UNITS

PERFORMANCE & TECHNICAL INFORMATION

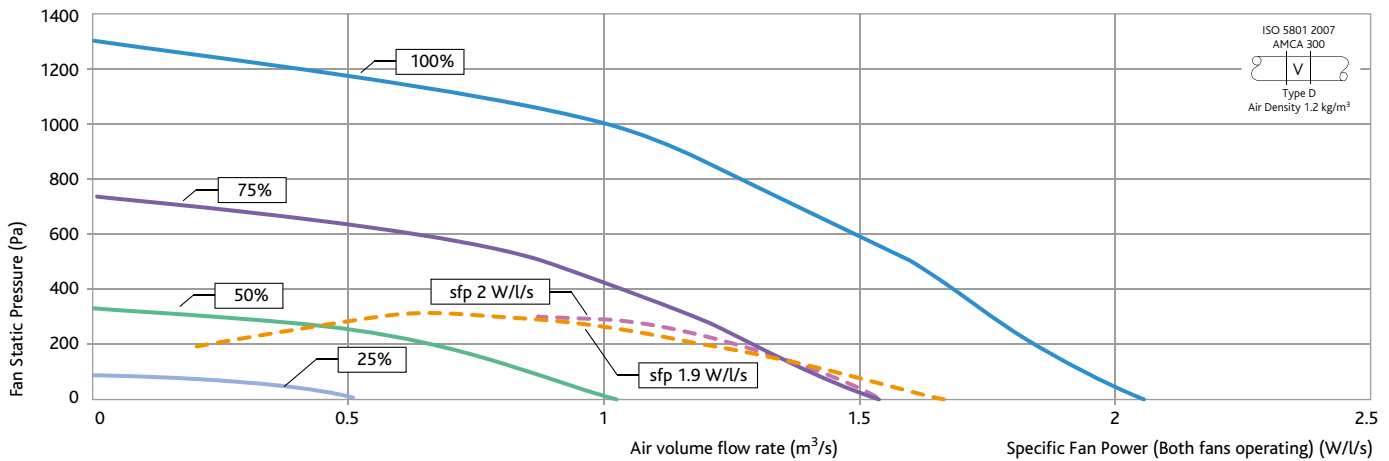

XBC85 UNIT PERFORMANCE

| Fan Speed | | External Static Pressure (Pa) | | | | | | | | Fan Speed | | External Static Pressure (Pa) | | | | | | | | | |
|-----------|----------------|-------------------------------|------|------|------|------|------|------|------|-----------|----------------|-------------------------------|------|------|------|------|-----|-----|-----|--|--|
| | | 0 | 50 | 100 | 150 | 200 | 300 | 400 | 500 | | | 0 | 50 | 100 | 150 | 200 | 300 | 400 | 500 | | |
| 100% | Airflow (m³/s) | 2.05 | 1.99 | 1.94 | 1.89 | 1.84 | 1.76 | 1.68 | 1.60 | 50% | Airflow (m³/s) | 1.02 | 0.93 | 0.83 | 0.72 | 0.61 | | | | | |
| | sfp (W/l/s) | 2.84 | 2.94 | 3.05 | 3.14 | 3.23 | 3.42 | 3.64 | 3.94 | | sfp (W/l/s) | 0.70 | 0.80 | 0.92 | 1.10 | 1.30 | | | | | |
| | dBa@3m | 50 | | | | | | | | | dBa@3m | 35 | | | | | | | | | |
| 75% | Airflow (m³/s) | 1.54 | 1.47 | 1.40 | 1.34 | 1.28 | 1.14 | 1.00 | | | Airflow (m³/s) | 0.51 | 0.30 | | | | | | | | |
| | sfp (W/l/s) | 1.60 | 1.69 | 1.80 | 1.88 | 2.02 | 2.30 | 2.71 | | | sfp (W/l/s) | 0.20 | 0.30 | | | | | | | | |
| | dBa@3m | 44 | | | | | | | | | | dBa@3m | 20 | | | | | | | | |

Specific Fan Power figures are the total for both fans operating.

For accurate figures, please refer to Nuair Fan Selection Programme at www.nuair.co.uk

| Unit Code | Voltage / Phase / Frequency | Input Power (W) | FLC / SC (A) | Max Operating Temperature | Fan Speed (rpm) | Unit Weight (kg) | Packed Weight (kg) | Pallet / crate dimensions (mm) |
|-------------|-----------------------------|-----------------|--------------|---------------------------|-----------------|------------------|--------------------|--------------------------------|
| XBC85-V-L** | 400 / 3 / 50 | 6000 | 9.5 / 9.5 | 40°C | 2550 | 780 | 880 | 3300L x 1200W x 1841H |
| XBC85-V-E** | 400 / 3 / 50 | 24000* | 35 / 35 | 40°C | 2500 | 780 | 880 | 3300L x 1200W x 1841H |
| XBC85-V-N** | 400 / 3 / 50 | 6000 | 9.5 / 9.5 | 40°C | 2500 | 780 | 880 | 3300L x 1200W x 1841H |

**Add relevant code ie: BC, ES, CO or AT for control type.

*Includes 18kW Electric Heater.

Add 'R' to relevant code for opposite configuration ie: XBC85-V-LES-R.

FAN UNIT DIMENSIONS (mm)

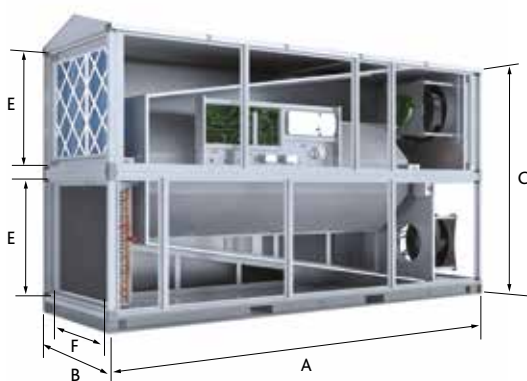

XBC85 FAN CONFIGURATION

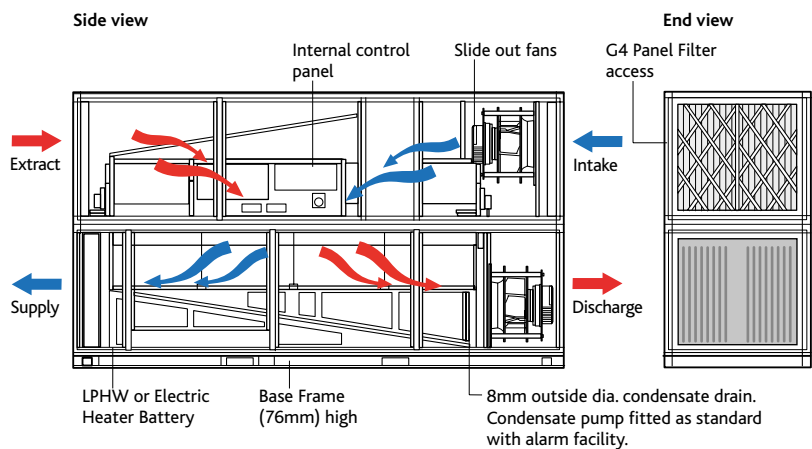

| Fan Unit Dimensions (mm) | | | Rectangular Aperture (mm) | | Weather Roof (All models) Code: XBC85-V-LESWP (mm) | | Service & Maintenance Requirements |
|--------------------------|------|-------|---------------------------|-----|--|--|------------------------------------|
| A | B | C | E | F | H x W x L | | |
| 3000 | 1000 | 1676* | 740 | 940 | 65 x 1000 x 3000 | | |

Weather roof is factory fitted only. Code example XBC85-V-LESWP.

*Includes base frame (76mm) high.

The unit is designed for side access as standard and must be installed with a minimum of clearance of 650mm from a wall or barrier. This will provide access to filters, coil, fan, heat exchanger, condensate tray and pump.

XBC85 VERTICAL HEAT EXCHANGE UNITS

PERFORMANCE & TECHNICAL INFORMATION

XBC85 FAN - SOUND DATA

| Fan Speed | Sound Power Levels (dB re 1 pW) | Frequency (Hz) | | | | | | | | Spherical dBA@3m | Fan Speed | External Static Pressure (Pa) | | | | | | | | Spherical dBA@3m |
|-----------|---------------------------------|----------------|-----|-----|-----|------|------|------|------|------------------|-----------|-------------------------------|-----|-----|-----|------|------|------|------|------------------|
| | | 63 | 125 | 250 | 500 | 1000 | 2000 | 4000 | 8000 | | | 63 | 125 | 250 | 500 | 1000 | 2000 | 4000 | 8000 | |
| 100% | Induct Intake | 81 | 82 | 93 | 83 | 79 | 76 | 73 | 68 | 50 | 50% | 66 | 67 | 78 | 68 | 64 | 61 | 58 | 53 | 35 |
| | Induct Supply | 81 | 80 | 86 | 80 | 80 | 73 | 60 | 51 | | | 66 | 65 | 71 | 65 | 65 | 58 | 45 | 36 | |
| | Induct Discharge | 84 | 86 | 93 | 88 | 90 | 85 | 81 | 76 | | | 69 | 71 | 78 | 73 | 75 | 70 | 66 | 61 | |
| | Induct Extract | 78 | 75 | 85 | 74 | 72 | 70 | 69 | 67 | | | 63 | 60 | 70 | 59 | 57 | 55 | 54 | 52 | |
| | Casing Radiated | 74 | 69 | 78 | 63 | 57 | 52 | 56 | 47 | | | 59 | 54 | 63 | 48 | 42 | 37 | 41 | 32 | |
| 75% | Induct Intake | 75 | 76 | 87 | 77 | 73 | 70 | 67 | 62 | 44 | 25% | 51 | 52 | 63 | 53 | 49 | 46 | 43 | 38 | 20 |
| | Induct Supply | 75 | 74 | 80 | 74 | 74 | 67 | 54 | 45 | | | 51 | 50 | 56 | 50 | 50 | 43 | 30 | 21 | |
| | Induct Discharge | 78 | 80 | 87 | 82 | 84 | 79 | 75 | 70 | | | 54 | 56 | 63 | 58 | 60 | 55 | 51 | 46 | |
| | Induct Extract | 72 | 69 | 79 | 68 | 66 | 64 | 63 | 61 | | | 48 | 45 | 55 | 44 | 42 | 40 | 39 | 37 | |
| | Casing Radiated | 68 | 63 | 72 | 57 | 51 | 46 | 50 | 41 | | | 44 | 39 | 48 | 33 | 27 | 22 | 26 | 17 | |

*Casing Radiated (Breakout).

ATTENUATOR DOUBLE DECK DIMENSIONS (mm), DYNAMIC INSERTION LOSS (dB) & WEIGHTS (kg)

| Attenuator* Code | Attenuator Dimensions | | | Dynamic Insertion Loss (dB) | | | | | | | | Attenuator Weight (kg) | Packed Weight (kg) |
|------------------|-----------------------|-------|----------|-----------------------------|-----|-----|-----|------|------|------|------|------------------------|--------------------|
| | Length | Width | Height** | 63 | 125 | 250 | 500 | 1000 | 2000 | 4000 | 8000 | | |
| XBC85-V-SIL900 | 900 | 1000 | 1676 | 0 | 6 | 8 | 18 | 22 | 20 | 16 | 15 | 185 | 190 |
| XBC85-V-SIL900WP | 900 | 1000 | 1741 | 0 | 6 | 8 | 18 | 22 | 20 | 16 | 15 | 190 | 195 |

*Attenuator sections are double deck, one piece module. **Includes 76mm base frame.

COUNTERFLOW HEAT EXCHANGER EFFICIENCY (%)

Performance based on:
Indoor Conditions 21 Deg C / 50 % RH

Key to performance curves

- Intake Temperature (Deg C)
- 5 Deg C Intake Typically Specified Values
- 3 Deg C Intake Typically Specified Values
- 1 Deg C Intake Typically Specified Values
- 6 Deg C Approx. Average outdoor temperature (UK heating season)

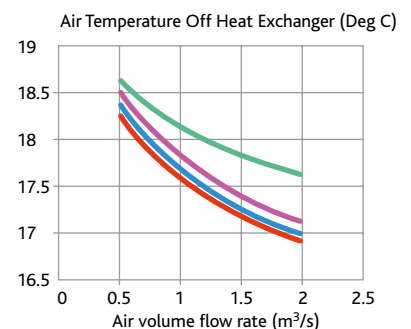
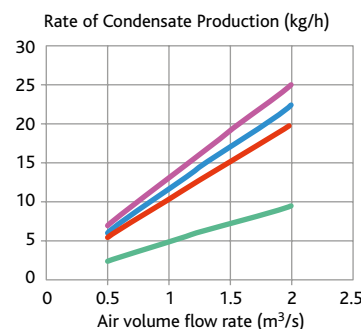
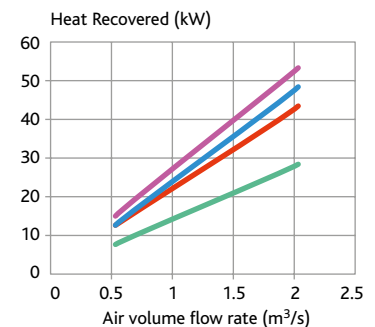
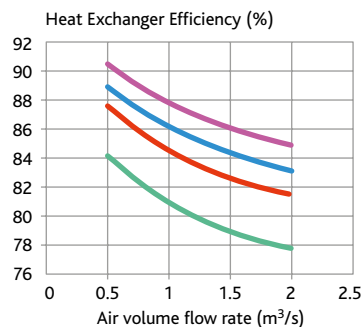

HEATING COIL DATA LPHW

| LPHW Deg C | Airflow (m³/s) | Output (kW) | Air Off Temp (C*) | Water flow (l/s) | Coil ΔP (kPa) | Pipe Connection (mm) | Valve ΔP (kPa) | Valve Type |
|------------|----------------|-------------|-------------------|------------------|---------------|----------------------|----------------|------------|
| LPHW 82/71 | 1.5 | 36.3 | 30.0 | 0.81 | 13.1 | 22 | 20 | 2 Port |
| | 1.1 | 31.6 | 33.9 | 0.69 | 9.4 | 22 | 20 | |
| | 0.75 | 24.7 | 37.4 | 0.54 | 5.8 | 22 | 20 | |
| LPHW 80/60 | 1.5 | 29.4 | 26.3 | 0.37 | 2.6 | 22 | 20 | 2 Port |
| | 1.1 | 25.6 | 29.4 | 0.31 | 1.9 | 22 | 20 | |
| | 0.75 | 20.0 | 32.2 | 0.24 | 1.1 | 22 | 20 | |
| LPHW 60/40 | 1.5 | 17.1 | 19.5 | 0.20 | 0.8 | 22 | 20 | 2 Port |
| | 1.1 | 14.8 | 21.2 | 0.17 | 0.6 | 22 | 20 | |
| | 0.75 | 11.6 | 22.9 | 0.13 | 0.4 | 22 | 20 | |

*Nb Limited to 30 Deg C for Ecosmart Units. Data based on 10 Deg C Air On temperature.

XBOXER XBC75 & 85 HORIZONTAL UNITS

ANCILLARIES

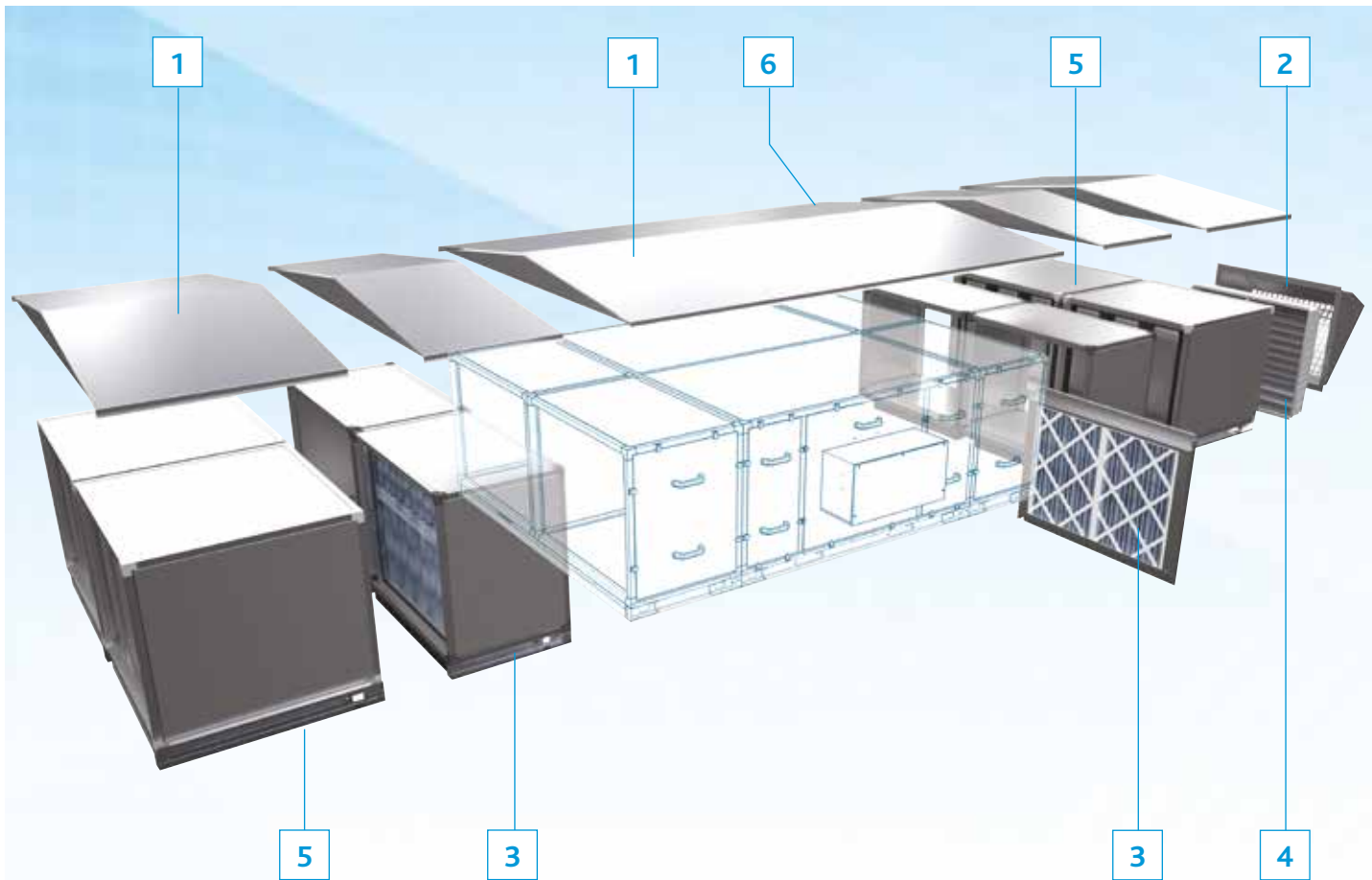

QUICK SELECTION GUIDE XBC75 & 85 HORIZONTAL UNITS - ANCILLARIES

| XBC Unit Size | Format | 1 | | 3 | | | |
|---------------|-----------------|------------------------------------|------------------|--|--------------|--------------------|----------------|
| | | Weather Kit BC, ES, CO & AT models | Weather Terminal | Filter & Module Options (All are side by side c/w empty module + base frame) | | Bag / Panel WP | Bag WP |
| | | | | F7 Bag / G4 Panel | G4 Bag | | |
| XBC75 | Horizontal | XBC75-H-***WP | XBC75-H-RT | XBC75-F7B/G4P-H | XBC75-G4B-H | XBC75-F7B/G4B-HWP | XBC75-G4B-HWP |
| XBC75 | Horizontal (-R) | XBC75-H-***-RWP | XBC75-H-RT | XBC75-F7B/G4P-HR | XBC75-G4B-HR | XBC75-F7B/G4B-HRWP | XBC75-G4B-HRWP |
| XBC85 | Horizontal | XBC85-H-***WP | XBC85-H-RT | XBC85-F7B/G4P-H | XBC85-G4B-H | XBC85-F7B/G4B-HWP | XBC85-G4B-HWP |
| XBC85 | Horizontal (-R) | XBC85-H-***-RWP | XBC85-H-RT | XBC85-F7B/G4P-HR | XBC85-G4B-HR | XBC85-F7B/G4B-HRWP | XBC85-G4B-HRWP |

*Weather roof is part of the unit code i.e. XBC75-H-LATWP. (Applies to all models).

Please note the 'H' models also have additional control cover.

| XBC Unit Size | Format | 4 | | | 5 | |
|---------------|------------|--|---|---|---|-----------------------------|
| | | Motorised Dampers (internal)** 230V (ES models only) Damper with 230V actuator | Shut-off Damper (CO models only) 24V non-modulating | No actuator (BC models only) Extended spindle | 2x Matching Silencers (side by side) Internal 900mm length*** | External 900mm length*** |
| XBC75 | Horizontal | XBC75-H-MD230V motor open/closed | XBC75-H-MD24V | XBC75-H-MD-NC | XBC75-H-SIL900 | XBC75-H-SIL900-WP |
| XBC85 | Horizontal | XBC85-H-MD230V motor open/closed | XBC85-H-MD24V | XBC85-H-MD-NC | XBC85-H-SIL900 | XBC85-H-SIL900-WP |

**Supplied loose, suitable for ES models.

Dampers for external use order Code: XBC**-RT (Roof Terminal).

***For other lengths contact Nuair.

| XBC Unit Size | Format | 6 | | | | | |
|---------------|-----------------|---|-----------------|-----------------|-----------------|-----------------|-----------------|
| | | Frost Coils* - Side by side complete with empty module and base frame | | | | | |
| | | BC Models | | ES Models | | CO or AT Models | |
| | | LPHW | Electric | LPHW | Electric | LPHW | Electric |
| XBC75 | Horizontal | XBC75-FCL-LNC-H | XBC85-FCE-LNC-H | XBC75-FCL-LES-H | XBC75-FCE-LES-H | XBC75-FCL-L**-H | XBC75-FCE-L**-H |
| XBC75 | Horizontal (-R) | XBC75-FCL-RNC-H | XBC85-FCE-RNC-H | XBC75-FCL-RES-H | XBC75-FCE-RES-H | XBC75-FCL-R**-H | XBC75-FCE-R**-H |
| XBC85 | Horizontal | XBC85-FCL-LNC-H | XBC85-FCE-LNC-H | XBC85-FCL-LES-H | XBC85-FCE-LES-H | XBC85-FCL-L**-H | XBC85-FCE-L**-H |
| XBC85 | Horizontal (-R) | XBC85-FCL-RNC-H | XBC85-FCE-RNC-H | XBC85-FCL-RES-H | XBC85-FCE-RES-H | XBC85-FCL-R**-H | XBC85-FCE-R**-H |

*All Frost Coils are for internal use. For external applications please add 'WP' to code i.e. XBC75-FCE-RAT-HWP.

XBOXER XBC75 & 85 VERTICAL UNITS ANCILLARIES

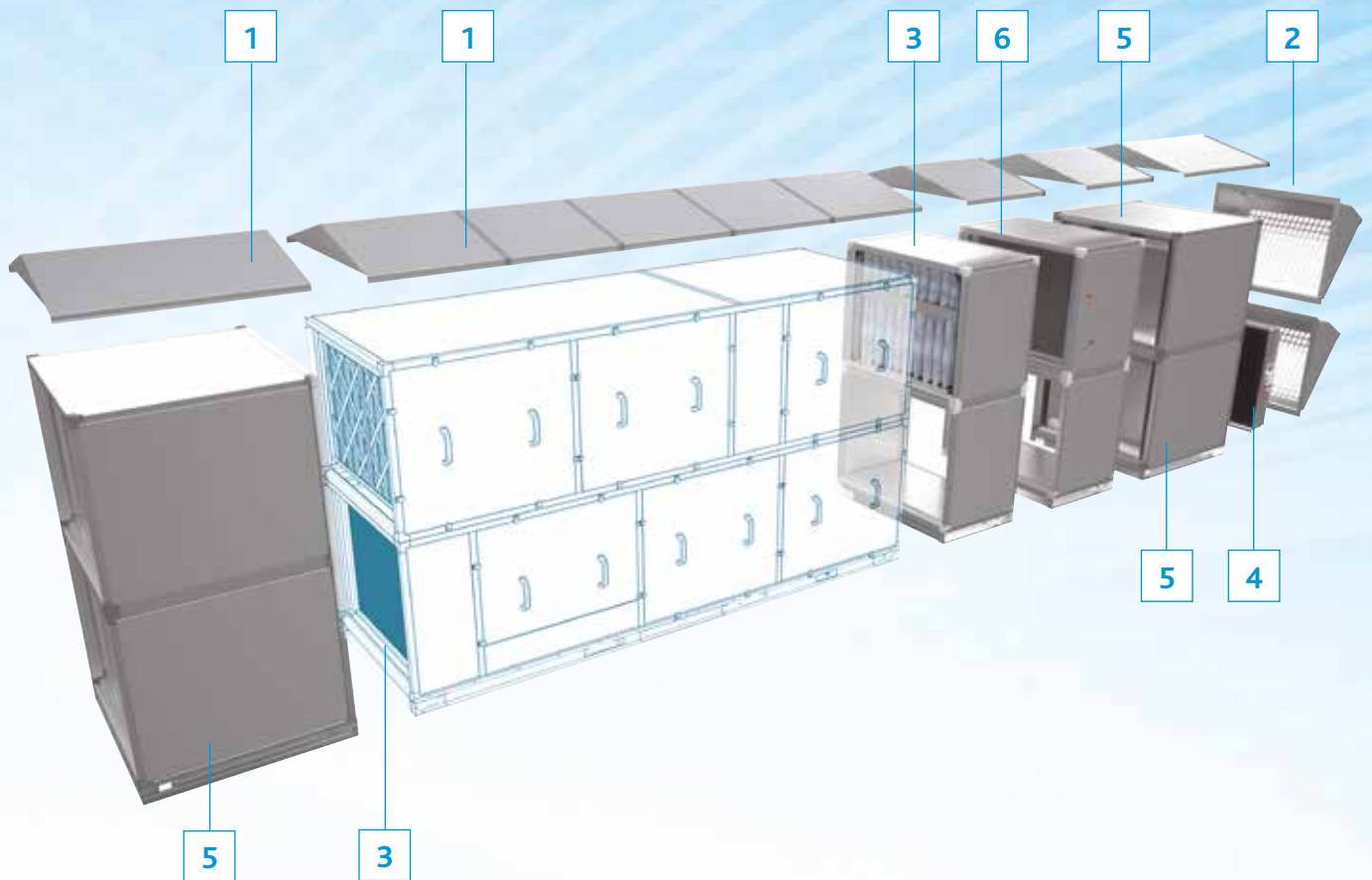

QUICK SELECTION GUIDE XBC75 & 85 VERTICAL UNITS - ANCILLARIES

| XBC Unit Size | Format | 1 | | 3 | | | |
|---------------|---------------------|--------------------------------|------------------|--|-------------|-------------------|---------------|
| | | Weather Kit BC, ES & AT models | Weather Terminal | Filter & Module Options (All are double deck c/w empty module + base frame) F7 Bag / G4 Panel | Bag | Bag / Panel WP | Bag WP |
| XBC75 | Vertical (standard) | XBC75-V-***WP | XBC75-RT | XBC75-F7B/G4P | XBC75-G4B | XBC75-F7B/G4P-WP | XBC75-G4B-WP |
| XBC75 | Vertical (-R) | XBC75-V-***-RWP | XBC75-RT | XBC75-F7B/G4P-R | XBC75-G4B-R | XBC75-F7B/G4P-RWP | XBC75-G4B-RWP |
| XBC85 | Vertical (standard) | XBC85-V-***WP | XBC85-RT | XBC85-F7B/G4P | XBC85-G4B | XBC85-F7B/G4P-WP | XBC85-G4B-WP |
| XBC85 | Vertical (-R) | XBC85-V-***-RWP | XBC85-RT | XBC85-F7B/G4P-R | XBC85-G4B-R | XBC85-F7B/G4P-RWP | XBC85-G4B-RWP |

*All models-weather roof is part of the unit code i.e. XBC85-V-LATWP.

| XBC Unit Size | Format | 4 | | | 5 | |
|---------------|----------|--|---|---|--|-----------------------------|
| | | Motorised Dampers (internal)** 230V (ES models only) Damper with 230V actuator | Shut-off Damper (CO models only) 24V non-modulating | No actuator (BC models only) Extended spindle | 2x Matching Silencers (double deck) Internal 900mm length*** | External 900mm length*** |
| XBC75 | Vertical | XBC75-MD230V motor open/closed | XBC75-MD24V | XBC75-MD-NC | XBC75-V-SIL900 | XBC75-V-SIL900-WP |
| XBC85 | Vertical | XBC85-MD230V motor open/closed | XBC85-MD24V | XBC85-MD-NC | XBC85-V-SIL900 | XBC85-V-SIL900-WP |

**Supplied loose, suitable for ES models.

Dampers for external use order Code: XBC**-RT (Roof Terminal).

| XBC Unit Size | Format | 6 | | | | | |
|---------------|---------------------|--|-----------------|-----------------|-----------------|-----------------|-----------------|
| | | Frost Coils* - Double decked complete with empty lower module and base frame | | | | CO or AT Models | |
| | | BC Models | | ES Models | | LPHW | Electric |
| XBC75 | Vertical (standard) | XBC75-FCL-LNC-V | XBC75-FCE-LNC-V | XBC75-FCL-LES-V | XBC75-FCE-LES-V | XBC75-FCL-L**-V | XBC75-FCE-L**-V |
| XBC75 | Vertical (-R) | XBC75-FCL-RNC-V | XBC75-FCE-RNC-V | XBC75-FCL-RES-V | XBC75-FCE-RES-V | XBC75-FCL-R**-V | XBC75-FCE-R**-V |
| XBC85 | Vertical (standard) | XBC85-FCL-LNC-V | XBC85-FCE-LNC-V | XBC85-FCL-LES-V | XBC85-FCE-LES-V | XBC85-FCL-L**-V | XBC85-FCE-L**-V |
| XBC85 | Vertical (-R) | XBC85-FCL-RNC-V | XBC85-FCE-RNC-V | XBC85-FCL-RES-V | XBC85-FCE-RES-V | XBC85-FCL-R**-V | XBC85-FCE-R**-V |

*All Frost Coils are for internal use. For external applications please add 'WP' to code i.e. XBC85-FCE-RAT-VWP.

XBC75-85 HEAT EXCHANGE UNITS

CONSULTANTS SPECIFICATION

OPERATION

The supply and extract ventilation unit shall be configured as indicated on the drawings. The heat recovery ventilation unit shall enable the room design conditions to be maintained by the effective and continuous control of ventilation rate, the integrated counterflow heat exchanger matrix and bypass, and LPHW heating facility.

The ventilation unit shall automatically vary the ventilation rate in the space dependent upon the signals received from the interconnected sensors and user interface (where provided). When signals are received, the unit shall vary its fan speeds proportionally until the desired set points are met.

The unit shall have the facility to commission the supply and extract fans individually via inbuilt maximum, minimum and offset speed adjustments. Each fan shall have stepless variable speed control (20 – 100% of maximum).

The unit shall be the XBC75-85** as manufactured by Nuair.

UNIT SPECIFICATION

The heat recovery ventilation unit shall have a maximum depth of 876mm (XBC75/85-H), 1416mm (XBC75-V) and 1676mm (XBC85-V) including base frame.

The one-piece ventilation unit shall be constructed with double skinned Aluzinc panels on an aluminium Pentapost frame with integral acoustic mineral fibre ensuring low breakout noise levels. The unit shall incorporate a high efficiency aluminium counterflow plate heat exchanger matrix with a thermal efficiency of up to 92%, fitted with a segmented 100% bypass facility and actuator (patent app.for) operating under automatic control. The automatic operation of the XBC bypass is determined by an algorithm that varies output based on temperatures, and whether the control system has been set to prioritise heating, ventilation or cooling.

The unit shall be protected from airborne contamination by high capacity pleated G4 panel filters (supply and extract).

The unit shall be fitted with ErP 2018 rated, low energy, high efficiency IP54 EC motorised fans providing low specific fan powers and stepless speed control, without tonal noise generation. Fan/motor assemblies have sealed for life bearings with an anticipated working life of 70,000 hours (L10) and shall be suitable for single phase supply.

Impellers shall be of high efficiency, performance and sound optimised backward curved design.

The unit shall be fitted with a LPHW heater battery (code example XBC75-V-LES), complete with factory fitted valve and actuator, terminating at the unit casing. Contact Nuair for Electric heater battery options.

The system shall have frost protection (Ecosmart models only) which shall, at temperatures below 4 degrees C, fully open the 2-port valve and only start the fan when the temperature within the chamber has risen above the designated set point.

The LPHW assembly shall be pressure tested at works to a minimum of 6 Bar. The control for the heaters shall be fully integrated and shall maintain a constant temperature*** to meet the system design requirements.

***The heating output (LPHW or electric) is automatically regulated to control the Air - Off condition.

The unit is also available without a heater fitted (code example XBC75-V-NBC).

The unit shall be constructed with removable side panels allowing full maintenance access.

The removable panels shall provide access to the following:-

- Supply and extract fan.
- Supply and extract filter.
- Condensate tray.
- All control adjustments (where included). Vertical models only.

UNIT CONFIGURATION

Standard Unit is supplied with internal control panel and connections on left side (refer to technical documentation). Horizontal units have externally mounted control panel. Opposite hand unit is available (example code XBC75-V-LES-R).

The ventilation unit shall comprise the following:-

Supply and extract fans, high efficiency counterflow plate heat exchanger matrix, supply and extract filters, full 100% automatic heat exchanger bypass, heating coil (as selected) & condensate drip tray, a condensate pump is installed in the unit and has an alarm function (connection by others). If the water level in the condensate tray exceeds a maximum level (for example, as a result of the discharge tube becoming blocked or frozen), the alarm contact will open. This contact is internally connected to the heat exchanger bypass actuator, and the unit will automatically be placed into bypass mode, preventing further condensate production. Unit operation will otherwise be unaffected.

Matching double skinned Pentapost construction attenuators can also be provided by Nuair.

CODE DESCRIPTION

XBC75-V-LES-R-WP
| | | | | | | |
1 2 3 4 5 6 7 8

1. XBOXER
2. Counterflow heat exchanger
3. Unit size (75 & 85)
4. V = Vertical, H = Horizontal
5. Type of heater battery:
L = LPHW, N = No heater
E = Electric heater
6. Control type:
AT = Ecosmart Adapt (Trend)
CO = Ecosmart Connect
ES = Ecosmart Classic
BC = Basic control
7. R = Opposite configuration
8. WP = Weather roof factory fitted only.

For further details on the ErP directive please refer to www.nuair.co.uk

XBC75-85 CONTROL OPTIONS

CONSULTANTS SPECIFICATION

BASIC CONTROL OPTION

Unit is provided with side access to internal mounted basic control housing for direct supply and extract fan motor wiring and for interfacing to custom built control panels.

The basic control housing (terminal box) is provided for the connections to the fans (400V 3Ph 50Hz LNE and 2-10V), and Electric heater terminal and thermal protection (where specified).

For this option, no sensors are fitted to the unit, but note that the plate heat exchanger bypass damper actuator is included suitable for 400V standard.

Units fitted with Basic Control (code example XBC75-V-EBC) have a 2 year warranty.

ECOSMART CLASSIC OPTION - DEMAND CONTROLLED VENTILATION

Provides the facility for energy saving via an intelligent stand-alone AHU function with local diagnostic status indication, or allows convenient integration with the client BMS with a minimal co-ordination requirement.

The factory fitted Ecosmart Classic control includes:- integral infinitely variable speed / duty control for the supply and extract fans, with independent minimum, maximum and offset adjustment for accurate commissioning. The control assembly is mounted internally.

The control features a run on timer and "background" ventilation function, and is provided with unit status indication, run and fail relays and interface connections for Ecosmart Classic sensors/enablers and system dampers.

The heat exchanger bypass is automatically operated according to temperature and a pre-defined strategy.

***The heating output (LPHW or electric) is automatically regulated to control the Air - Off condition.

The Ecosmart control module can additionally be connected to provide the following integrated BMS interfaces.

- 0 - 10 volt inputs. This will enable the following functions:- Switch the unit ON/OFF. Variable speed / duty control, Switch from low speed to high speed, Enable heating/cooling.
- 2 No. Volt free contacts give fan run and failure unit status indication.

Units fitted with Ecosmart Classic control (code example XBC75-V-LES) have a 5 year warranty.

ECOSMART CONNECT OPTION – ENHANCED DEMAND CONTROLLED VENTILATION

A comprehensive unit control specification - factory fitted and tested to provide guaranteed operation from a single supplier – one who will take responsibility.

The unit integrated Ecosmart Connect system provides the facility for operational efficiency and energy saving by allowing a comprehensive range of unitary control functions and / or full BMS integration (by others) via standard BACnet (MS/TP).

The system incorporates a web access enabled controller, and is augmented by application specific unit interface and diagnostic circuits. Controller software is optimised and pre-configured, and each unit / control assembly is fully functionally tested at works (Refer to technical documentation for full controller functional specification).

Units fitted with Ecosmart Connect control (code example XBC75-H-CO) have a 5 year warranty. (Refer to 'Description of control' for further details).

ECOSMART ADAPT WITH TREND OPTION – ENHANCED DEMAND CONTROLLED VENTILATION

A comprehensive unit control specification - factory fitted and tested to provide guaranteed operation from a single supplier – one who will take responsibility.

The unit integrated Ecosmart Adapt system provides the facility for operational efficiency and energy saving by allowing a comprehensive range of unitary control functions and / or full BMS integration (by others) via standard BACnet IP configuration.

The system incorporates a web access enabled Trend IQ422/12/LAN/BAC/230 controller, and is augmented by application specific unit interface and diagnostic circuits. Controller software is optimised and pre-configured, and each unit / control assembly is fully functionally tested at works (Refer to technical documentation for full controller functional specification).

Units fitted with Ecosmart Adapt control (code example XBC75-V-LAT) have a 5 year warranty. (Refer to 'Description of control' for further details).

The unit shall be the XBC75-85 as manufactured by Nuaire.

XBOXER XBC75-85 HORIZONTAL & VERTICAL UNITS

UNIT WIRING

UNITS WITH ECOSMART CLASSIC CONTROL & LPHW COIL CONTROL (CODING EXAMPLE XBC**-*-LES)

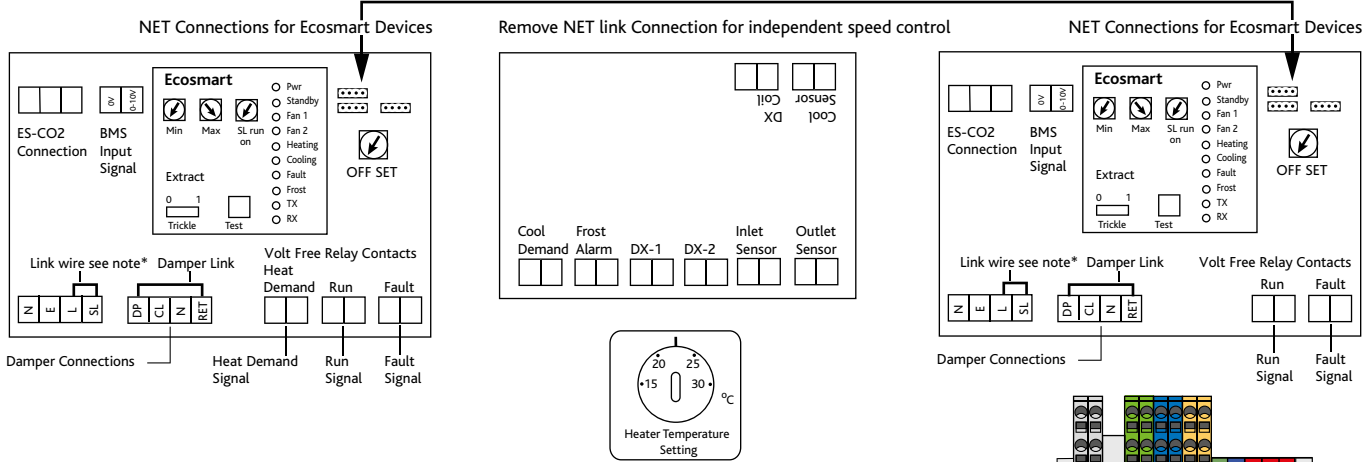

All inter-connections between circuit boards, blowers and sensors are made at the factory. This diagram only shows the essential field wiring points for clarity.

*Remove link wire if switched live signal, an enabler or BMS signal is connected.

Note: If a damper is not fitted, connect (Factory Fitted) a link wire from OP to RET. This will cancel the delay.

Volt Free contacts

Note: That the volt free contacts are not fused.

If these are used to power any external equipment, the installer must provide adequate fusing or other protections.

These contacts are rated at 5A resistive, 0.5A inductive. **Run connections** - These contacts are closed when the fan is running.

Fault connections - No fault = the contacts are closed. **Fault** = the contacts are opened.

Heat demand - contacts closed when heating is selected.

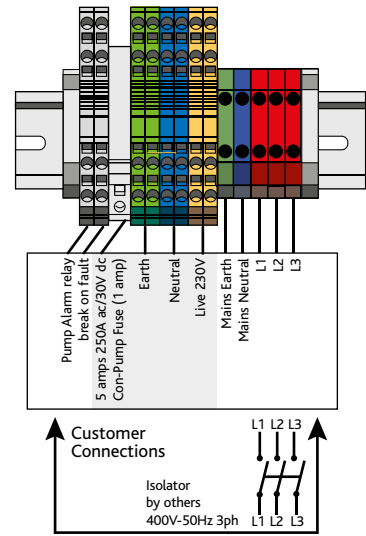

UNITS WITH ECOSMART CONTROL & ELECTRIC HEATER (CODING EXAMPLE XBC**-*-EES)

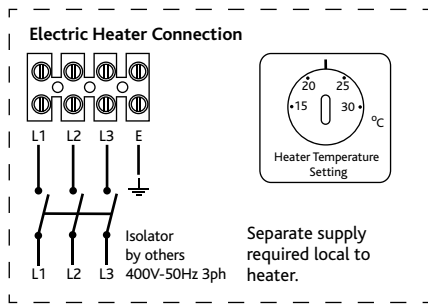
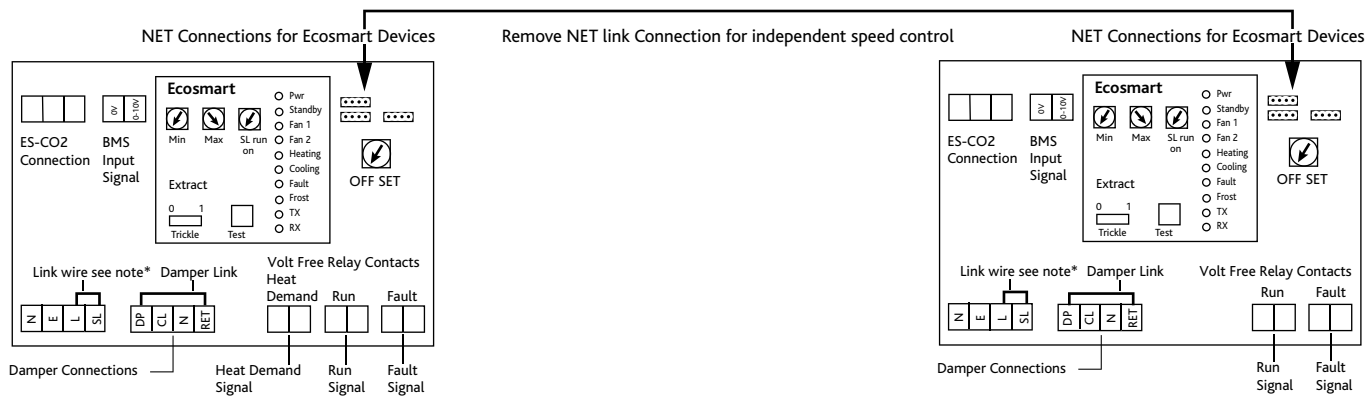

All inter-connections between circuit boards, blowers and sensors are made at the factory. This diagram only shows the essential field wiring points for clarity.

*Remove link wire if switched live signal, an enabler or BMS signal is connected.

Note: If a damper is not fitted, connect (Factory Fitted) a link wire from OP to RET. This will cancel the delay.

Volt Free contacts

Note: That the volt free contacts are not fused.

If these are used to power any external equipment, the installer must provide adequate fusing or other protections.

These contacts are rated at 5A resistive, 0.5A inductive. **Run connections** - These contacts are closed when the fan is running.

Fault connections - No fault = the contacts are closed. **Fault** = the contacts are opened.

Heat demand - contacts closed when heating is selected.

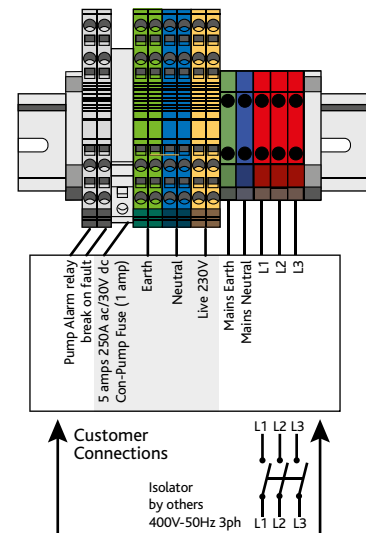

ECOSMART WIRING For Ecosmart Connect and Adapt Trend wiring please contact Nuair.

XBOXER XBC75-85 HORIZONTAL & VERTICAL UNITS

UNIT WIRING

UNITS WITH ECOSMART CLASSIC FAN ONLY CONTROL (CODING EXAMPLE XBC**-*-NES)

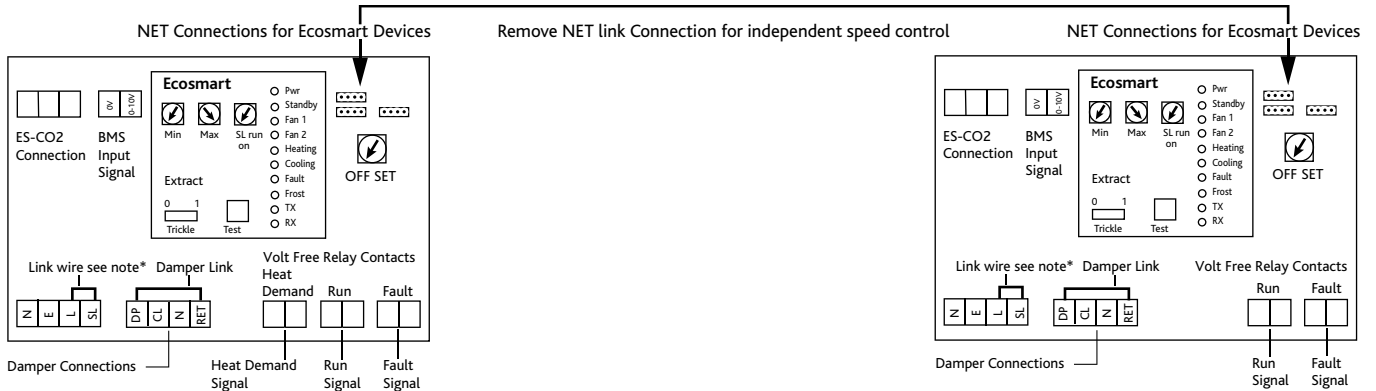

All inter-connections between circuit boards, blowers and sensors are made at the factory. This diagram only shows the essential field wiring points for clarity.
 *Remove link wire if switched live signal, an enabler or BMS signal is connected.
 Note: If a damper is not fitted, connect (Factory Fitted) a link wire from OP to RET. This will cancel the delay.

Volt Free contacts
 Note: That the volt free contacts are not fused. If these are used to power any external equipment, the installer must provide adequate fusing or other protections. These contacts are rated at 5A resistive, 0.5A inductive.
Run connections - These contacts are closed when the fan is running.
Fault connections - No fault = the contacts are closed. Fault = the contacts are opened.
Heat demand - contacts closed when heating is selected.

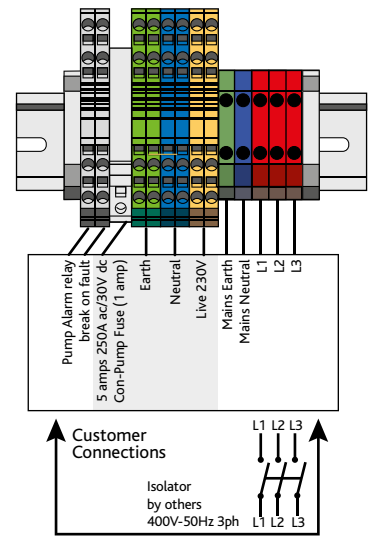

WIRING - FOR UNITS SUPPLIED WITHOUT ECOSMART CONTROL

LPHW & NO HEATER XBC75-85 ONLY

Supply Fan

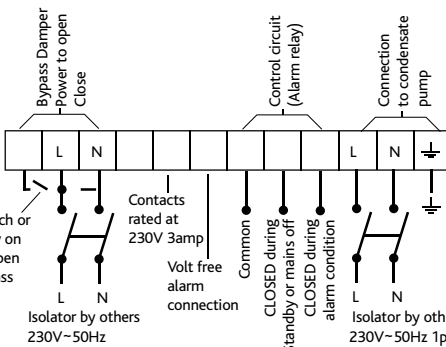
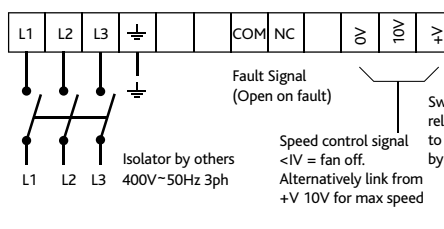

Extract Fan

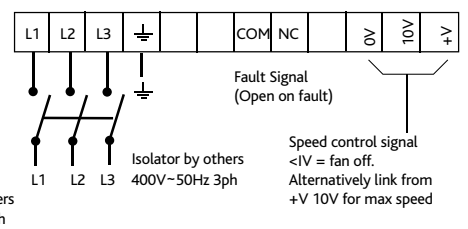

ELECTRIC HEATER XBC75-85 ONLY

Supply Fan

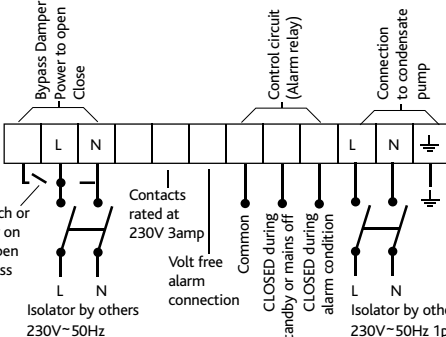
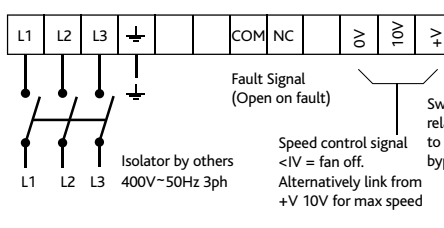

Extract Fan

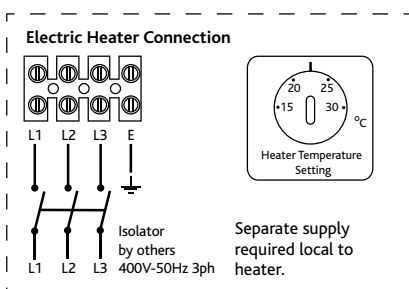
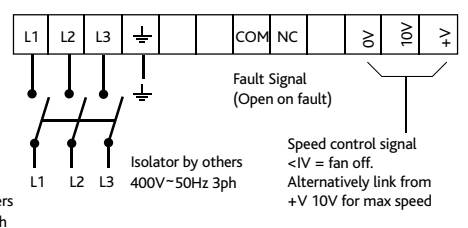

ECOSMART WIRING For Ecosmart Connect and Adapt Trend wiring please contact Nuaire.

CONSTANT PRESSURE FOR ECOSMART UNITS ON DEMAND VENTILATION WHEN YOU NEED IT MOST



XBC85-V-LCO-CP ▶



▲ XBC75-H-LES-CP

LOWER NOISE & ENERGY CONSUMPTION

ACHIEVES BUILDING REGULATIONS

UNIQUE INTELLIGENT DESIGN PRACTICE

NUAIRE XBC ECOSMART CONSTANT PRESSURE SYSTEMS ARE DESIGNED FOR CONTINUOUS VENTILATION AND BECAUSE THEY FEATURE ECOSMART ON DEMAND CONTROL, COSTS ARE KEPT LOW.

When a room is occupied, a PIR or switch triggers the damper, which immediately operates as required, returning to background ventilation when the room is vacated.

The Constant Pressure Fan offers up to 70% savings over conventionally controlled central systems and should the primary fan or motor fail, the automatic change over guarantees uninterrupted ventilation because it works at reduced duty the unit consumes less power and is very quiet. This energy efficient ventilation solution is extremely cost effective to run and simple to install as all components are delivered assembled, wired and tested.

Specify Nuaire Ecosmart Constant Pressure and blow away your client's energy bills.

■ **MATCHED SILENCER OPTIONS** - Matched silencers double walled with acoustic infill provide the best acoustic solution. Internal and external silencers available.

■ **SAVES ENERGY** - Up to 70% saving over conventionally controlled central systems.
- Not needlessly extracting conditioned air
- Fan speed/motor power dictated by demand requirement.

■ **LESS POWER CONSUMPTION** - System works at reduced duty therefore consumes less power and is very quiet.

■ **TRUE DEMAND VENTILATION** - Only the areas that require ventilation receives ventilation.

■ **UNIQUE DIRECT ACTING MULTI-POSITION DAMPER NRG GRILLE** - Ensures operation only when room occupied with integrated PIR.

Note: XBC10-65 Constant Pressure works on extract fan only. XBC75-85 works with supply & extract.



WHAT IS CONSTANT PRESSURE?

Constant Pressure Variable Volume systems (CPVV) are systems of fans, controls and sensors installed in a multi-room ducted system.

The system is intended to provide continuous background ventilation when the served spaces are unoccupied and will automatically increase the ventilation rate when any room is occupied to the design requirements.

Only the room requiring the increased ventilation will receive the ventilation.



NRG Control Grille/Damper (optional).



Humidity Control (optional)



Inline CVD Damper (optional).

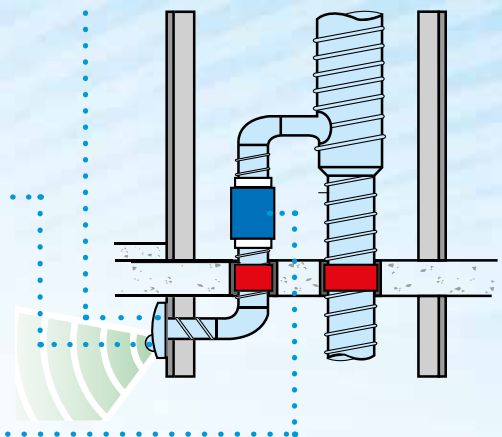

FLEXIBLE SOLUTION

INTERNAL OR EXTERNAL APPLICATIONS

-XBC's options are available for ceiling applications, plant rooms and roof tops. Duty range to 1.5m³/s.

ENERGY EFFICIENT CONTROLS - Full

Ecosmart control compatibility provides a simple 'plug & go' control solution with BMS interface and trickle and boost as standard.

ECOSMART CONNECT CONTROL SYSTEM -

Allows stand-alone control and full BMS integration via BACnet (MS/TP). The system controller is augmented by application specific unit interface and diagnostic circuits. Controller software is pre-configured and the unit/control assembly is functionally tested at works (for further details of Ecosmart Control options refer to Ecosmart Controls Brochure). N.B Ecosmart Classic, Connect & Adapt have constant pressure options.

SAVES TIME & MONEY ON SITE

PRE-WIRED - All components assembled, wired and tested at the Nuairé manufacturing facility.

- Simply plug and go. No wiring required between fan and damper.

DUCT MOUNTED CVD DAMPERS -

For unobtrusive flexibility.

5 YEAR WARRANTY - On Ecosmart Classic and Ecosmart Connect and Ecosmart Adapt Trend Constant Pressure models for peace of mind.

MAKES LIFE EASIER



(Model: XBC45-H-LCO-CP) ▶

External roof mounted heat recovery unit fitted with external weather roof. Typical applications include Schools, Hotels, Apartments & Offices.

CONSTANT PRESSURE HEAT RECOVERY

PERFORMANCE & TECHNICAL INFORMATION



HOW DOES CONSTANT PRESSURE WORK?

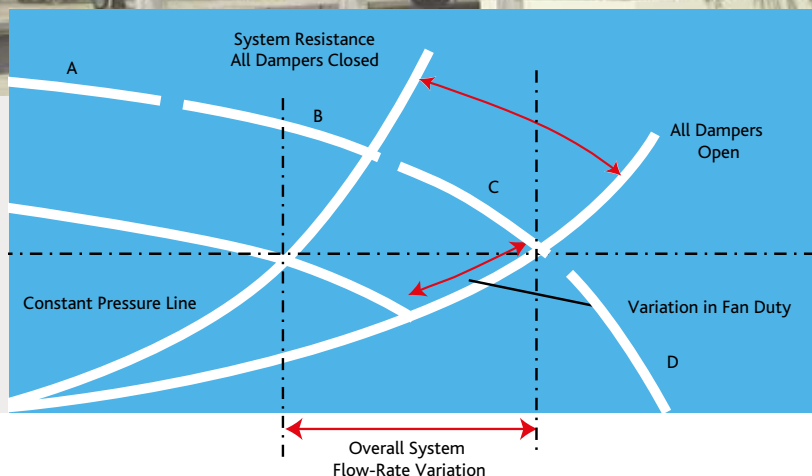

Independent extract grilles are installed at duct termination points in each of the spaces served, the grilles (for the benefit of this exercise we will consider our NRG grilles) are set to provide one of four boost ventilation rates. They are connected independently to a 230V AC supply via 230/12V transformers.

The grilles have in built occupancy sensors (PIR) and when the PIR detects movement the grille is driven open, when a grille opens the system pressure falls, the fan control detects the change and adjusts the motor speed to maintain the target pressure.

Grilles will stay open for approximately twenty minutes after the last movement has been seen and when it closes the control again compensates for the change in system pressure by adjusting fan speed.

By opening the grilles the pressure in the system will fall. The control system in the fan senses this and automatically speeds up to provide the higher volume and equalise the system pressure. This works in reverse with the grille closing, increasing the system pressure, automatically reducing the fan speed and again equalising the system pressure. Hence a constant pressure variable volume system. There is no inter-connection between grille/damper and fan.



WHAT ARE NRG GRILLES?

A motorised two-position grille offered by to compliment the range of constant pressure fans. They have:

- A connecting spigot to suit 125mm duct opening.
- Four settable positions for boost vent rate, Positions 1, 2, 3 & 4 are indicated on the grille by the appropriate number of dots. The grille is pre-set at 5mm open to guarantee the trickle ventilation rate and the other positions are set via a trigger on the front of the grille.
- An integral occupancy sensor (PIR) which is not adjustable.
- They are 12V-AC operating and are supplied with 230/12V AC transformers for installation local to the grille. For ease of installation the transformer can be connected to an independent spur or ring main.
- Integrated run on timer providing approx. twenty minutes overrun, which is non-adjustable.
- Grille resistance is dependent upon the air volume passing through it, see the resistance charts.
- There is no interconnecting wiring between damper/grille & fan.

CONSTANT PRESSURE HEAT RECOVERY PERFORMANCE & TECHNICAL INFORMATION



CVD DAMPER

The CVD damper will work in the same way as the NRG but is mounted in-line and will be 230V operated responding to external switching devices such as humidistat, remote PIR, light switch, door switch etc. The in-line version has an in built motorised volume control damper to regulate the maximum

flow through the branch connection. It has an airflow sensor that continuously monitors the airflow and adjusts the damper position accordingly.

THE INTEGRATED CONTROL PACKAGE

Is mounted in the fan chamber and consists of the XBC package including:

- The inverter, which is the mechanism that varies the speed of the motors
- A Ecosmart control printed circuit board which converts the data from the pressure transducer to an input signal to the inverter.
- Terminals to connect the incoming mains supply and remote status indicators.

THE PRESSURE TRANSDUCER

Is precisely calibrated and mounted in the fan chamber and is connected to the Ecosmart control board. It continually monitors system pressure, compares the actual to the target allowing the control board to convert the data to an input signal to the inverter, thereby adjusting the motor speed to compensate for the system change.

THE SET-UP BOX

Is mounted on the external face of the unit case, it is connected to the control pack by a low voltage lead and includes

- A potentiometer to set the target pressure.

All achieved whilst fan is running without re accessing the fan chamber.

PERFORMANCE - CVD DAMPER

A nominal pressure drop must be allowed in order to ensure adequate airflow through the damper.

To ensure the airflow pattern through the damper produces consistent readings; the pressure drop across the damper should not exceed the recommended value. Recommended values are listed in the table below and shown in the performance envelope of each damper.

*Recommended maximum operating pressure to ensure the damper would work within calibration limits. Keep the duct velocity as low as possible to ensure the system produces the lowest energy usage, preferably below 5m/s.

**Allow 90Pa for duties below 100l/s and 150Pa for duties between 100l/s and 125l/s.

| Code | Nominal Design Pressure Drop | Maximum Pressure Across Damper* |
|--------|------------------------------|---------------------------------|
| CVD100 | 60Pa | 120Pa |
| CVD125 | 70Pa | 140Pa |
| CVD150 | 80Pa | 160Pa |
| CVD200 | 90Pa** | 200Pa |

PERFORMANCE ENVELOPE FOR CVD100

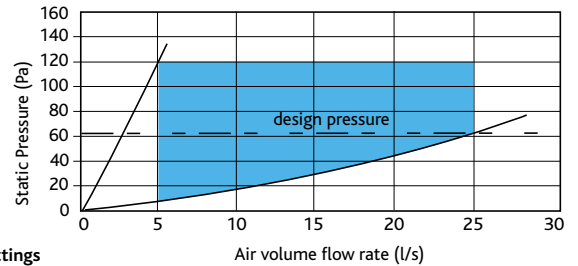

CVD100 Settings

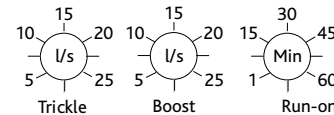

PERFORMANCE ENVELOPE FOR CVD125

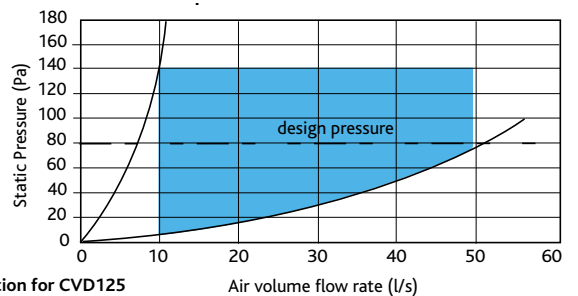

Dial calibration for CVD125

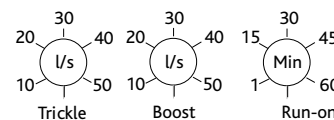

PERFORMANCE ENVELOPE FOR CVD150

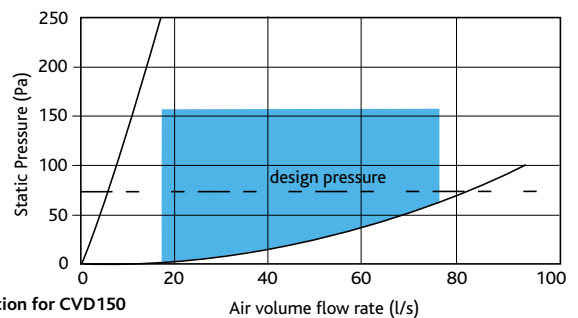

Dial calibration for CVD150

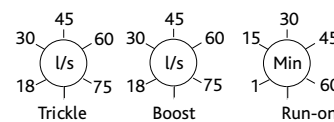

PERFORMANCE ENVELOPE FOR CVD200

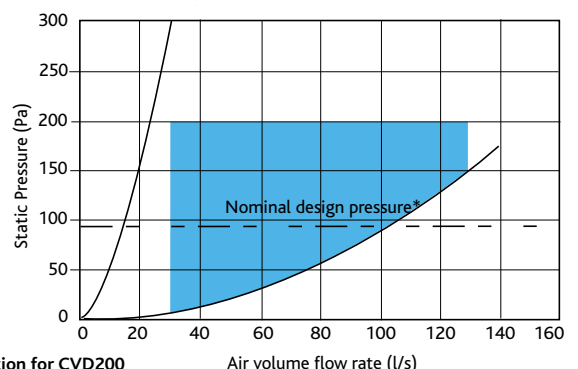

Dial calibration for CVD200

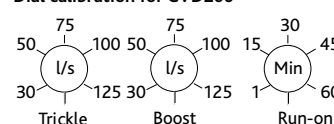

WORKING WITH CUSTOMERS

THE NUAIRE RANGES OF HEAT RECOVERY PRODUCTS HAVE DOMINATED THE HVAC MARKET FOR OVER 10 YEARS. IN PARTICULAR NUAIRE HAS A LONG HISTORY OF DESIGNING VENTILATION PRODUCTS SPECIFICALLY FOR SCHOOLS AND UNIVERSITIES.

Nuaire boasts its own in-house Applications Engineering team which works in close partnership with its clients to ensure the best possible solution for their project and has even built a 30-seat mock classroom, incorporating the very latest ventilation technology, at its UK headquarters.

Designed to display and test its range of innovative school ventilation systems, the classroom is the only one of its kind among UK ventilation manufacturers.



Above: An underbench classroom unit. Project: (Trinity College).



Over the years it has become obvious that a standard 'one fan fits all' solution doesn't always meet the requirements of the project.

Whether there is a limitation of ceiling space or indeed no ceiling space and a bulkhead has to be built, Nuaire can work with its customers to provide the appropriate ventilation solution for their building type.



WORKING WITH CUSTOMERS



Above: Project specific heat recovery unit. Project: (Liverpool schools).

PROJECT: MANCHESTER SCHOOLS



CLIENT: MANCHESTER CITY COUNCIL

**CONSULTING PRACTICE:
BCM MANCHESTER**

While ventilation systems typically sit within the ceiling void of a building, this project design requires the units to be completely exposed so Nuaire adapted the finish of the unit to a gloss white to enhance the lighting levels and coordinate with the interior design of the classroom.

Brian Morris, Managing Director of BCM, said:

"We have worked closely with Nuaire, following a competitive process, to design a solution which fits our strategy for achieving Manchester's challenging criteria.

They are compact, quiet and energy efficient and meet all the necessary building regulations."

THE COMPLETE HEAT RECOVERY SOLUTION

Mechanical extract with heat recovery.

Heat recovery systems offer efficiency and control over the air quality and volume within the space. Providing tempered air into areas whilst extracting moisture laden air from 'wet' areas. Heat recovery is ideal for multi-storey accommodation.

Heat Recovery with Constant Pressure.

Why ventilate empty rooms? Constant pressure is ideal for accommodation applications. A central extract system provides the necessary extraction, linked to all 'wet' areas such as bathrooms via a central fan, which is normally positioned on a roof and unique direct-acting multi position CVD dampers or NRG grilles ensures operation only when room is occupied.



◀ (Model: XBOXER XBC45-H-NTWP). External roof mounted heat recovery unit fitted with external weather roof.



▲ (Model: MRXBOX95AB-WH2). Heat recovery unit mounted in a kitchen cupboard.



ZONAL & CENTRALISED UNITS



XBOXER XBC10-65
(up to 0.79m³/s)
Market leading heat recovery units, up to 96% efficient.



BOXER BESPOKE
(up to 20m³/s)
Designed to meet project specific applications. Options include rotary wheels, plate heat exchangers & run around coils.

(Model: XBC85-V-LESWP) ▶
Externally mounted with
weather roof.



LOCAL UNITS



MRXBOX95AB-WM1
(up to 52l/s)

Compact heat recovery range for wall and cupboard mounting. Low voltage DC fans and motors.



MRXBOX95AB-WM2
(up to 90l/s)

Compact heat recovery range for wall and cupboard applications. Can commission supply and extract fans independently.



MRXBOX95AB-WH1
(up to 110l/s)

Compact heat recovery range for wall and cupboard applications. Can recover up to 95% of normally wasted heat.



MRXBOX95AB-WH2
(up to 180l/s)

A high duty MVHR unit with low specific fan power (SFP). Low watt EC fans and high efficiency impellers for quiet running. For wall and cupboard applications.



NEW XBOXER XBC75 & 85
(up to 1.5m³/s)

Vertical & horizontal heat recovery units, up to 96% efficiency.



CONSTANT PRESSURE DAMPERS (CP)

Energy efficient volume control damper for use with constant pressure fans. Wall (NRG) or duct (CVD) mounted.



MRXBOX95B-LP1E

Low profile with a thermal efficiency of up to 80%. Ecosmart ready.

FOR MORE INFORMATION

www.nuaire.co.uk

COMMERCIAL

www.nuaire.co.uk/commercial



NUAIRE

Western Industrial Estate | Caerphilly | CF83 1NA

t +44 (0)29 2085 8200 | f +44 (0)29 2085 8222 | e enquiries@nuaire.co.uk

www.nuaire.co.uk

As part of our policy of continuous product development Nuaire reserves the right to alter specifications without prior notice. Telephone calls may be recorded for quality and training purposes.

Part Number 671606 April 2018.

